



SINO

DIGITAL READOUTS

SDS6

Operation Manual

GUANGZHOU LOK SHUN CNC EQUIPMENT LTD.

Dear Users:

1、 Thank you for purchasing the products of the digital readout device of Guangzhou Lokshun CNC Equipment Ltd. "Sino", "  " is its registered trademark. It is a precision measurement products and mainly for various types of manual machine tools machining or testing equipment to provide a Detection and localization function.

2、 Guangzhou Lokshun CNC Equipment Ltd has the "" registered trademarks.

Notice: Please read the following safety instructions and precautions for safety operation of the new digital display meter device.

When using the manual:

- Chapters and sections are listed in the table of contents( see P5~6 ahead).
- This manual includes some instructions for panel keys of SDS6 digital display meter and other series, including.

| | |
|---------|--|
| SDS6-2V | the readout used for 2 axis milling machine and grinding machine and lathe machine |
| SDS6-3V | the readout used for 3 axis milling machine and lathe machine and discharging processing |

It is recommended that:

- Instructions for panel keys of the SDS6 digital display meter that is applicable to this manual are listed in P1~4 of the above Section 1.
- Read through follow safety precautions and Section 2( see P102~107), which are very important to the safe operation of your digital display meter.

Safety Precautions:

Caution:

- Do not dampen or splash coolant directly onto the unit to avoid electric shock or fire.

Warning:

- Do not open the enclosure optionally to avoid electric shock, there is no element repairable by the user inside. Turn to appointed technician for repair.

-
- If the unit is not used for a long time, the chargeable lithium batteries for data retention inside the digital display meter will be damaged. Please contact Guangzhou Lokshun CNC Equipment Ltd. agent or professional technicians for battery replacement when using it again.

Notes:

- Disconnect power plug promptly if the digital display meter emits smog or peculiar smells, when an electric shock or fire may be caused when continuing to use it. Please contact Guangzhou Lokshun CNC Equipment Ltd. or dealer and never attempt to repair it by yourself.
- The digital display meter constitutes a precision detection device with an optical electronic ruler. Once the connecting wires between the two parts are broken or damaged on the surface during use, error in detection data might be caused, to which the user should pay special attention.
- Do not repair or refit the digital display by yourself, otherwise a fault or damage might be caused. In the case of abnormality, please contact Guangzhou Lokshun CNC Equipment Ltd. or dealer.
- Once the optical electronic ruler used in the digital display meter is damaged, do not replace it with rulers of other brands, because products of different companies have their respective characteristics, indicators and wiring. Never make wiring without the guide of professional technicians, otherwise the digital display meter might get into fault.



The displacement sensor complies with 2006/95/EC directive for low-voltage electric apparatus and 2004/108/EC directive for EMC.

Our company has passed the authorization and the audit of ISO9001 Quality System, ISO14001 Environmental System, OHSAS18001 Occupational Health and Safety System.

Notice: The Interpretation of this manual belongs to Guangzhou Lokshun CNC Equipment Ltd.

Forgive product upgrades without further notice.

SDS6-3V READOUT PANEL AND KEYBOARD

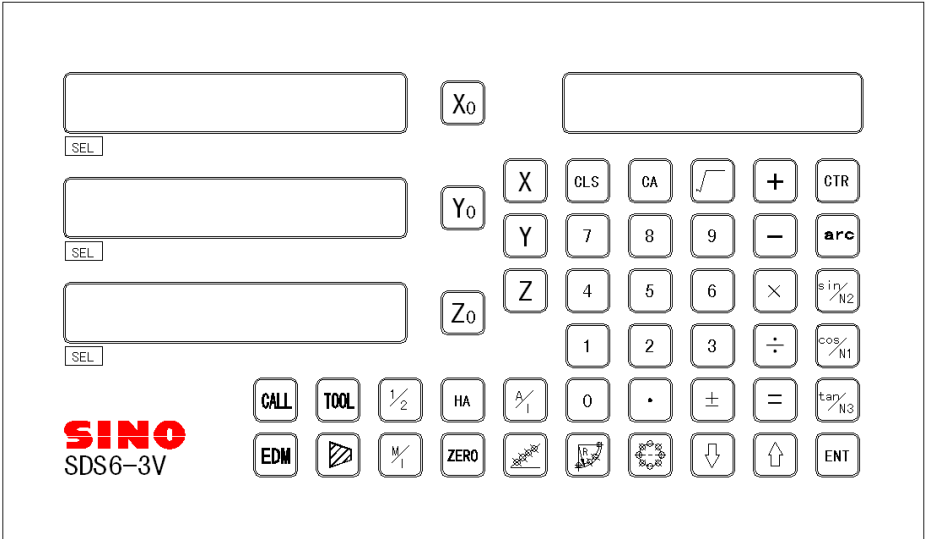

SDS6-2V READOUT PANEL AND KEYBOARD

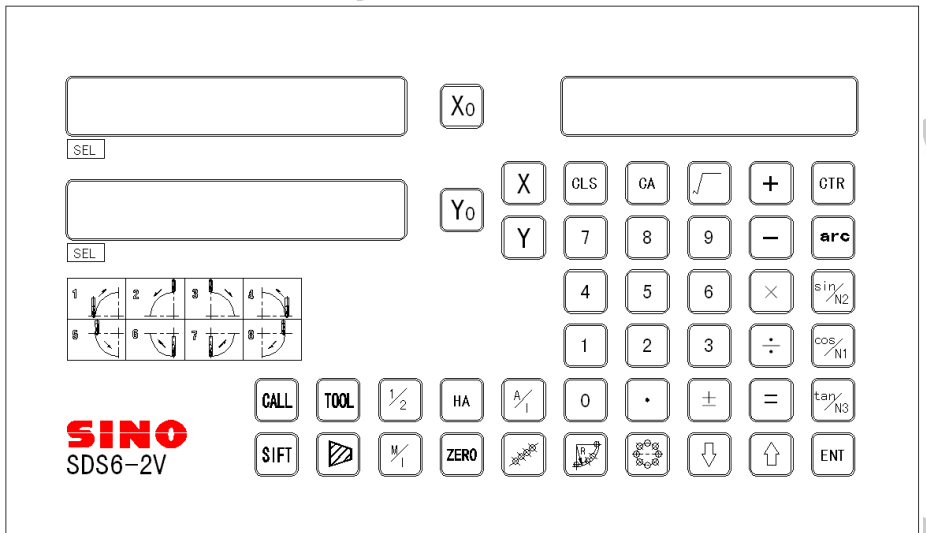

Caption of the Keyboard of SDS6



_____ Keys for **cleaning the displayed value to zero**



_____ Keys for **Axis selection**



_____ **Entry keys for digits**



_____ **Operation Key (in Calculation function key)**



_____ **Calculation function key (in Calculation function key)**



_____ **Input (calculation result) canceling key (in Calculation function key)**



_____ **Key for “Inverting” Trigonometric Functions (in Calculation function key)**



_____ **Square root calculating key (in Calculation function key)**



_____ **Entry keys for decimal point**



_____ **Entry key plus or minus symbol**



Key for entering data



Key for cleaning the displayed value to zero



Function key for getting one half



Key for the conversion the meter System/ British system display



Function key for Sleep



Function key for 200 zero Position



R angular ARC function key (ARC Function key)



Function key for circle equally Dividing (PCD Function key)



Function key for drilling holes along an oblique line



Angular surface processing function key; In calculation function as sine trigonometric function key

Illustration of Panel and Keyboard



Progressive inner chamber processing function key; In calculation function as cosine trigonometric function key



Tool compensation function key; In calculation function as tangent trigonometric function key



Key for the conversion of relative/absolute display



Key for the selection of upper/lower term or plane procession



Key for taper measure function



Key for calling 200 tool storeroom



**Key for input 200 tool storeroom
Key for radius**



Function key for machine output (EDM)

(only SDS6-3V readout has)



Function key for data filtration

(only SDS6-2V readout has)

Catalogue

| | |
|---|-----------|
| A. Basic Functions | 1 |
| B. Smooth R | 15 |
| (Be the same with: MIIL_MS , MIIL_M) | |
| C. Simple R | 27 |
| (Be the same with: 2V-MIIL_MS , 2V-MIIL_M) | |
| D. Hole Drilling Along An Oblique Line | 34 |
| (Be the same with: MIIL_MS) | |
| E₁. The Function For 200 Point Subsidiary Zero Position | 38 |
| (Be the same with: MIIL_MS, MIIL_M, EDM) | |
| E₂. The Function For 200 Point Subsidiary Zero Position | 47 |
| (Be the same with: LATHE) | |
| E₃. The Function For 200 Point Subsidiary Zero Position | 55 |
| (Be the same with: 2V-GRIND) | |
| F. PCD Circle Equally Dividing Holes | 62 |
| (Be the same with: MIIL_MS, MIIL_M, EDM) | |
| G. Angular Surface Processing | 66 |
| (Be the same with: MIIL_MS) | |
| H. The Function-Calculator Function | 71 |
| (Be the same with: MIIL_MS) | |

I. Tool Diameter Compensation 74
 (Be the same with: 3V-MIIL_MS)

J. 200 Tool Storeroom..... 77
 (Be the same with: LATHE)

K. The Function Of Measure For Taper 81
 (Be the same with: LATHE)

L. (EDM)Matching Output Function 83
 (Be the same with: 3V-EDM)

M. Digital Filter Function 93
 (Be the same with: 2V-GRIND)

N. N3 Function95
 (Be the same with: 2V-MIIL_MS)

O. The Progressive Progressing of rectangular Inner chamber 99
 (Be the same with: 2V-MIIL_MS)

P. Additional sheet..... 102

A.

Basic Functions

We take pleasure to tell you that this machine tool optical digital display ruler device you are using is the one most popular in Europe.

You will be able to use this device easily after you have read this manual thoroughly. Thank you!

I. Usage

1. Start, Self check

- 1) Selecting the power voltage, switching the power on
- 2) Self check of the meter
- 3) Self check finished, enter working mode

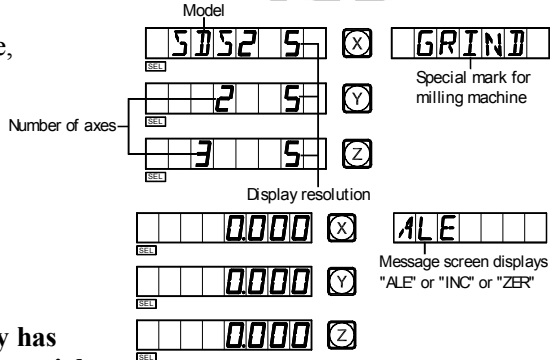

Note: Two axial readout only has

X-axis and Y-axis, three axial

readout has X-axis, Y-axis and Z-axis. The lathe machine readout display "LATHE"; the grinding machine readout display "GRIND"; the multifunctional milling machine readout display "MILL_MS"; the universal milling machine readout display "MILL_M"; the discharging processing readout display "EDM".

2. Setting of System

In process of self check, key  then the system enter setting mode after self check finished.

- 1) Setting axis X resolution.



Setting different resolution according to keying different numbers.

| Number key | 0 | 1 | 2 | 5 | 7 | 8 | 9 |
|----------------|----|---|---|---|-----|-----|-----|
| Resolution(um) | 10 | 1 | 2 | 5 | 0.1 | 0.2 | 0.5 |

Key  → , next step

- 2) Setting axis Y resolution.

Setting method alike axis X

Key  → , next step



- 3) Setting axis Z resolution.

Setting method alike axis X.



value displays in Y-axis LED.

Press → , next step

Note: only 3 axis lathe machine has this function.

9) choose compensation type

choose line error compensation “LINEAR”;

choose Segmented error compensation
“SEGMENT”;

Press → , next step

10) choosing the precision of calculation

the decimal fraction bits of the calculation is 3;

the decimal fraction bits of the calculation is 4;

the decimal fraction bits of the calculation is 5;

11) Self test.

Key twice, the Self-test program started
then key to quit.

(Note: Setting of axis Z only applies to three axis digital readout.)

3. Returning the displayed Value to zero

1) It is possible to return to zero any point, take the example of X axis display.

2) Key →

4. Presetting data

1) As shown in the figure, after the processing of Hole A finished, the position of the working piece has been adjusted, Hole B is to be processed.

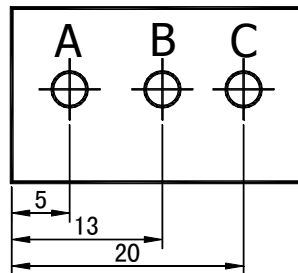

2) Align the Tool with Hole A.

3) Select the key for axis, key .

- 4) Key **5**, Enter the value (If the entered value is wrong, key **X** and enter the correct one again)

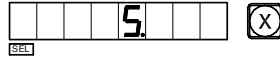

- 5) Key **ENT**, (If any mistake is found now, repeat steps 3~5).



- 6) Move the machine table to the position of 13, and the processing at Point B can start.



5. Absolute/relative/user coordinate display mode.

Key **↑** **↓**, the absolute/relative display mode will convert one the other, following are operations.

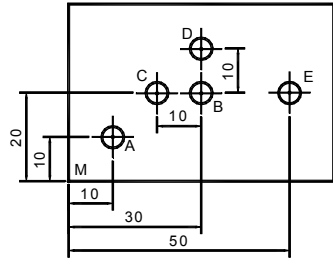

- 1) Let the Tool point to Point M reset under the absolute mode.

Key **↑** or **↓**

Key **X** → **CLS**

Y → **CLS**



- 2) Move the machine tool to Position A.



- 3) Move the machine tool to Position. B.



- 4) Key **↑** → **X** → **CLS**
Y → **CLS**



- 5) Move the machine tool to Position C.



- 6) Move the machine tool to Position D.





7) Return to the absolute mode 





8) Move the machine tool to Position E.

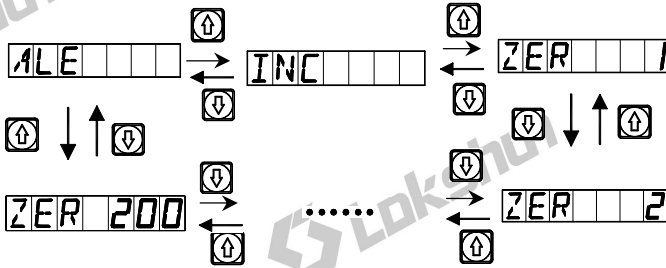

Note: The resetting in the absolute and the relative display mode must be done separately. In absolute display mode, “ALE” is displayed on Message Screen. It is in absolute display mode when “INC” is display Message Screen.

Keying ,  can also realize the conversion between the two display mode, and it is also possible to enter the display mode of 200 sets of user coordinates, as shown in the following circulating schematic diagram.



Key  and enter the display mode of 200 sets of user coordinates directly.
Enter the number



Key digit keys, such as



Entered the display mode of No. 50 set of relative coordinates.

6. key display

As shown in the figure, the enter between two points is to be found.

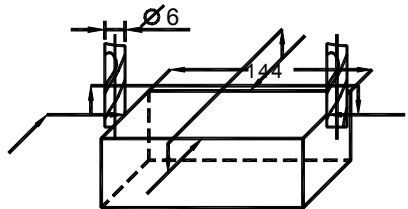

1) Let the tool touch the one edges of the working piece and Return the X-axis displayed Value to zero, then move the tool

along the direction of arrow and let it come to touch the other edges of the working piece, then do the next step can determine the center position.

2) Key axis key X



3) Key $\frac{1}{2}$



4) Move the machine tool to bring the axis displayed value into zero, and the center position is reached.



(in the same method can determine the center positions of Y-axis and Z-axis).
note: Lathe machine without this function.

7. “R/D” (Radius/Diameter) Switch Display.

X axis datum on the center line.

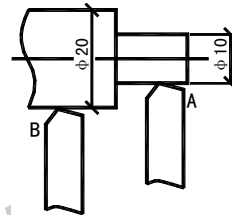

1) Cutting tool in place A.

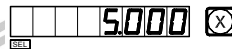

2) Key X \rightarrow $\frac{1}{2}$



3) Move the cutting tool to place B.



4) Key X \rightarrow $\frac{1}{2}$



Notes: only lathe machine has this function; A lit “SEL” indicator means diameter display, Y、Z axis is not able to display so.

8. The switch of the summing axis value displaying type.

In the function of Y, Z axis summing, press arc can switch the display mode.

1) if the former display mode is summing, press arc switch to separate mode.



2) if the former display mode is separation, press arc switch to summing mode.



Note: only the lathe machine digital displayer has the function; the parameter option” whether the Y\Z axis summing display” must be set summing mode; the Z axis only displays the digital value, and can’t be preset value or clear.

9. "M/I" (The mm System/inch System) Conversion Display.

Key , the size displayed in the mm System/inch system will convert one to the other.

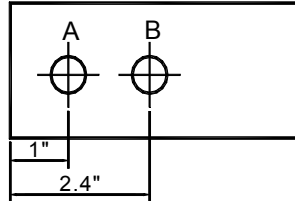



1) The original display is in the mm system, and the display in inch is desired.



2) Key 



3) Key  or  choose the bits of decimal; (4 bits or 5bits)



Key 

4) Enter processing mode of Hole B



5) Key  can convert directly to mm System



10. Segmented error compensation

Note: only in Metric system can do Segmented error compensation . After Segmented error compensation, the display can be converted freely between Metric system and Imperial system.

There are two methods for Segmented error compensation of the digital display meter:

1. To carry out error compensation taking the start point as the mechanical origin. (Figure 1)
2. To carry out error compensation taking the 1st absolute zero of the raster ruler as the mechanical origin. (Figure 2)

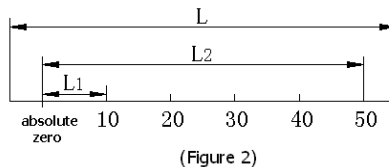
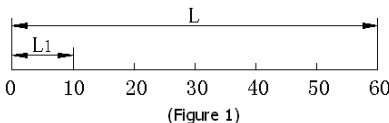

L: The distance of effective range of raster ruler

L1: Length of the compensation segment

L2: Effective distance of the compensation segment

1. Set up according to the sketch map 1. The parameter set-up method is as follows:



1) Move the raster ruler to the



smallest end of the coordinate data Enter into the ALE right-angle coordinate system

2) Press **X** → **%** enter into the input function of multi-segment compensation of X axis (the set-up method for Y axis and Z axis is the same as X axis.)

3) Input the quantity of compensation segments

(Figuer 1):

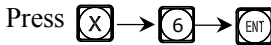

(Figuer 2):

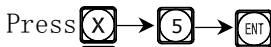

Press **↓** next step

Remarks: The quantity of compensation segments of any axis is input in X axis.

4) Input the length of compensation segments

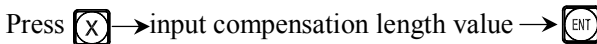

Press **↓**, next step

5) Find the mechanical origin

There are two methods for setting the compensation origin. **LEFT ZERO**

1、 directly press **ENT** to choose the current position as origin.

2、 Press → to choose the 1st absolute zero of the raster ruler as the mechanical origin.

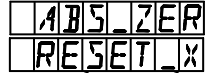

Move towards the positive direction of X axis of the machine tool and search for the 1st absolute zero of the raster ruler as the mechanical origin. After find the origin, then auto enter the next step for data input. This time the X-axis displays the raster ruler fact value, and Y-axis displays the former compensation value(if the readout is first compensated, the Y-axis display a uncertain value).

6) Input the compensation setup of the 1st segment

At this time, firstly move the



X-axis raster ruler towards the



positive direction. When the raster ruler is moved around the length of the compensation value (the compensation length in Step 4 is $\pm 0.5\text{mm}$), the display of Y axis is dimmed and enters into the status of value setting status, at this time input the standard value of Y axis or the exact value measured by laser (this method is implemented in every set-up point)

Press → →

(When press , Y-axis will displays the X-axis's value, and that means the compensation value has been setup. If the value input is wrong, don't move the raster ruler, and press , then press , this time the digit-display LED of Y-axis will be in input state, and input the right value again.)

Press and enter into the next set-up point

Remarks: In this function, the display of X axis is the coordinate value, while Y axis displays the standard value or the measurement value by laser

coordinate value

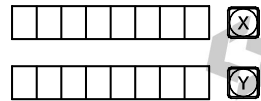

The standard value or the measurement value by laser

7) Input the compensation setup of the 2nd segment

Press → →



Press , enter into the next set-up point



8) Input the compensation setup of the 3rd segment

Press **3** → **0** → **ENT**

00030007 ⊗ NO0003
00030007 ⊕

Press **↓**, and enter into the next set-up point

9) Input the compensation setup of the 4th segment

Press **4** → **0** → **ENT**

00040007 ⊗ NO0004
00040007 ⊕

Press **↓**, and enter into the next set-up point

10) Input the compensation setup of the 5th segment

Press **5** → **0** → **ENT**

00050007 ⊗ NO0005
00050007 ⊕

Press **↓**, and enter into the next set-up point

11) Input the compensation setup of the 6th segment

Press **6** → **0** → **ENT**

00060007 ⊗ NO0006
00060007 ⊕

After the setup is finished, press **↶** key to exit.

Remarks: The input zone for the compensation value of Y axis and Z axis is the coordinate display zone of X axis.

2. The cancellation method of Segmented compensation value



The Segmented compensation value is only aimed at the digit display meter, raster ruler and machine tool set up together. If the raster ruler or digit display meter whose Segmented compensation value is set up in a machine tool is moved to another machine tool, the Segmented compensation value needs to be reset. When the Segmented compensation function is not needed, the Segmented compensation value is to be cancelled. The cancellation method is:





According to the set-up method of Segmented compensation indicated above, when it is indicated to input the quantity of compensation points, input 0 as the compensation segment, then all the compensation setup parameters are initialized. At this time, all the compensation values set up before are cancelled automatically.

3. Finding the function of the mechanical origin

If there is power off when the raster ruler is moving, or the raster ruler is moved before the power is on, after re-start, the mechanical origin needs to be found again. Because of movement in power off or before power on, the coordinate origin of the machine tool can not match the value in the digit display meter. If the mechanical origin is not found, the misplaced relationship is brought into the later user coordinate system. As when calculating the user coordinate, the Segmented compensation value is found according to the wrong mechanical coordinate, thus there is big error of the displayed coordinate.

The method of finding mechanical origin is as follows:

1. Move the raster ruler to the position which is initially set up as the mechanical origin, and then set up Segmented compensation. When inputting the quantity of compensation segment and the compensation length, do not make any change, and press  directly to skip. Enter into the interface for choosing compensation method, press . The interior of digit display meter handles automatically. At this time, directly press  key to quit the Segmented compensation setup, and finish finding the mechanical origin. (Remarks: It is applicable to setting up parameters according to sketch map 1)

2. Firstly move the raster ruler to the smallest value, and then set up Segmented compensation. When inputting the quantity of compensation segments and the compensation length, do not make any change, and press  directly to skip. Enter into the interface for choosing compensation method, press  →  to enter X axis to find the status of absolute zero. Move the raster ruler towards the positive direction. When the absolute zero is found, it is the mechanical origin. The interior of digit display meter handles automatically. At this time, directly press  key to quit the Segmented compensation setup, and finish finding the mechanical origin. (Remarks: It is applicable to setting up parameters according to sketch map 2)

Note: When find the mechanical origin, the user-coordinate will resume.

Advise: find the mechanical origin before start work after power on to assure the coordinate origin of the machine tool can match the value in the digit display meter.

11. Linear Error Compensation

The linear error compensation function is used to make the linear correction of the system error of the grating metering system.

Correction factor $S = (L - L') / (L / 1000)$ mm/m

L---the actually metered length (mm)

L'---the displayed value on digital display meter (mm)

S---the actually factor (mm/m), "+" symbol means the actual length is larger, and "-" symbol means the actual length is smaller.

Compensation range: -1.500 mm/m ~ +1.500 mm/m

Example: The Actual metered length of the machine tool machine table is 1000 mm, and the display value on the digital display meter is 999.98 mm.

$$S = (1000 - 999.98) / (1000 / 1000) = 0.02 \text{ mm/m}$$

1) Select the axis 

2) Key 



modifier coefficient used last time

3) Key the new correction factor in:

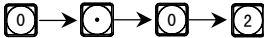

4) Key 



Note: The linear error compensation can only be carried in absolute display mode (the message screen displays ALE) and metric system;

12. Power Interruption Memory

During the processing of a working piece, there may occur power interruptions or needed temporary turnoffs, the digital display box will automatically store the working state (such as the working mode in every axis, displayed data and the linear error compensation factor) just before every interruption event in its memory. Every time when the machine is turn on again, the digital display box will recover to its working state just before the interruption event after self checking, and the valve just before the interruption (turn off) event will recover, and the processing will continue.

13. Sleep Switch (no this function for the digital display box with 3-axis display)

The switch on the back panel of the digital display box may once be turned off during the processing of a working piece. It is true that the SDS Series digital box has its interruption memory, but the machine tool may have been moved after the event. In such a case, when the machine is turned on again, the working state just before the interruption event will be displayed again, but this is not the actual new situation. If the operator want to suspend the processing for his (her) rest time or any time he (she) is occupied by other thing, the sleep switch can be used to avoid the above mentioned situation.

In not ALE working state, if there a need of Sleep Switch Off, key , the digital display box will turn off the display. When restarting the processing, key , and the box will turn on all the display. No matter how the machine tool was moved after the display had been turned off, the box will “see” and “keep in mind” the end state after the machine tool have been moved. When the display has been turned on again, the displayed working state will be the actual state.

Note: When the sleep switch has been turned off, the digital display box is not really in the turnoff sate; if the power switch on the back panel of the box has been turned off, the sleep switch losses its function.

B.

Smooth R

(Be the same with: MIIL_MS 、 MIIL_M)

Smooth R Arc Calculation function (ARC Function)

In the processing of moulds, it often happens that the processing of circular arc is indispensable. For the case that the processing is arranged for a single working piece, the required contour is simple and not too much processing of circular arc will be involved, it may involve much dissipation in both time and money to arrange the job to a digital control machine tool.

The advanced smooth R arc Calculation function provided in SDS6 model digital display box makes it possible to complete the processing of a single piece such as moulding copper electrode easily and quickly with a universal milling machine. This arc Calculation function makes it possible to freely control the smoothness of the circular arc. The distance between two adjoining working points is uniform, the smoothness of the circular arc can be control through the control of this distance.

This function is used in the processing of circular arc. ①The display on the message window prompts the operator to enter all the parameters have to be defined, so it is very easy to operate. ②This function can based on the input maximal cut (MAX CUT) calculates out the most proper depth of cut, and so, the smoothness of the circular arc in thoroughly in the operator's control.

1) An operator without experience in this must at first get a clear understanding of the coordinate system in using the Arc R calculating function.

Note: The arrow direction is the positive direction of coordinate axes.

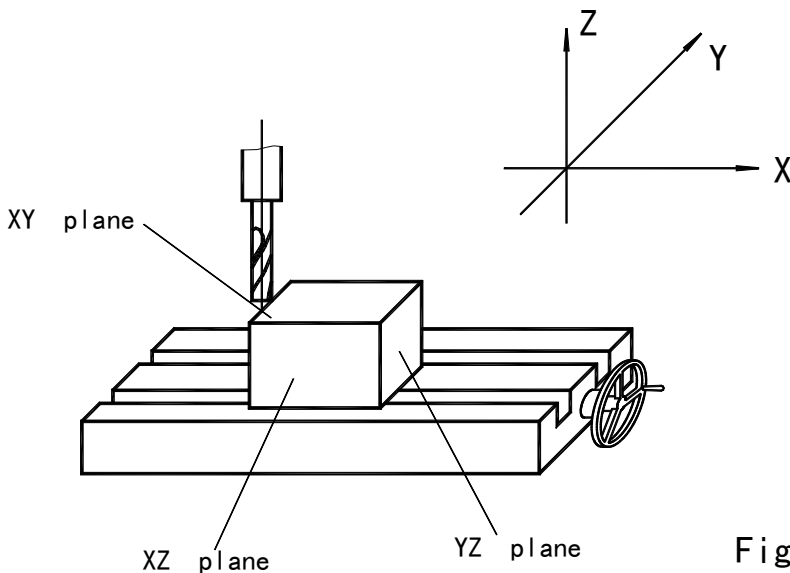
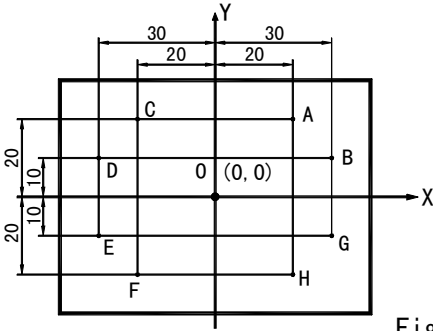

Fig. 1

2) Let us recognize the plane coordinate and the start and end angles of a circular arc.

In Plane XY、XZ or YZ, the coordinate of a point is its position with respect to the zero point on the plane.



- The coordinate of zero point O:(0,0)
- The coordinate of Point A:(20,20)
- The coordinate of Point B:(30,10)
- The coordinate of Point C:(-20,20)
- The coordinate of Point D:(-30,10)
- The coordinate of Point E:(-30,-10)
- The coordinate of Point F:(-20,-20)
- The coordinate of Point G:(30,-10)
- The coordinate of Point H:(20,-20)

Fig. 2

In Plane XY、XZ or YZ, the start and end angle of a circular arc is counted in anti clockwise.

As shown in Fig. 3:

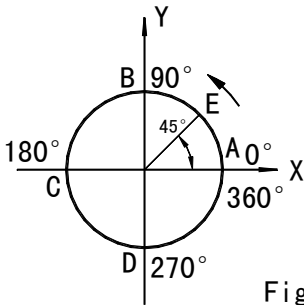



Fig. 3

- Arc AB
 - From A to B $0^\circ \rightarrow 90^\circ$
 - Form B to A $90^\circ \rightarrow 0^\circ$
- Arc BC
 - From B to C $90^\circ \rightarrow 180^\circ$
 - From C to B $180^\circ \rightarrow 90^\circ$
- Arc CD
 - From C to D $180^\circ \rightarrow 270^\circ$
 - From D to C $270^\circ \rightarrow 180^\circ$
- Arc DA
 - From A to D $360^\circ \rightarrow 270^\circ$
 - From D to A $270^\circ \rightarrow 360^\circ$
- Arc BE
 - From E to B $45^\circ \rightarrow 90^\circ$
 - From B to E $90^\circ \rightarrow 45^\circ$

3) The procedure in using the Arc R Calculation function.

As shown in the figures(a)、(b)and (c), reset all the axes after finishing the installation of Tool and the related tool setting (assign the position of the tool after tool setting as the zero point).

Key , enter the Arc R Calculation function.

1. Select the smooth R function (SMOOTH).

2. Select the processing plane XY、XZ or YZ.
(ARC-XY)
(ARC-XZ)
(ARC-YZ)

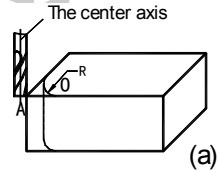

3. Enter the center position of the circular arc:(CT POS)

The center position of the circular arc is the position of the circle with respect to the position of the tool just after tool setting and reset.

In the processing the arc in XZ or YZ plane:

As shown in Fig. (b) when a flat end milling tool is used, the circle center position is the position of Point O with respect to Point B on the tool.

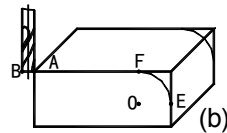

As shown in Fig. (c) when a circular arc milling tool is used, the circle center position is the position of Point O with respect to Point C on the tool.

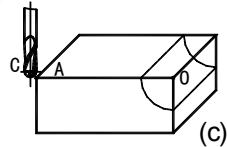

In the processing of the arc in Plane XY, as shown in Fig. (a), the circle center position is the position of the center axis of the tool.

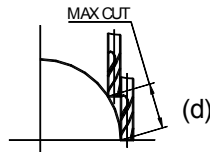

4. Enter the radius of the circle (RADIUS)

5. Enter the diameter of the tool (TL DIA)

Note: In the processing of the arc in Plane XZ or YZ, as show in Fig. (b) an end mill is used and the working point is Point B, the diameter of the tool is not involved in the processing, so, you must enter (TL DIA) =0.

6. Enter the maximal cut (MAX CUT)

When this function is used in the processing of circular arc, the cut of every cutting feed is uniform, as shown in Fig. (d).

7. Enter the start angle of the circular arc (ST ANG)

This determines the position of the first cut feed in the processing of circular arc. As show in Fig.(b), the start angle is 0° if the arc is to be processed from Point E to Point F, and 90° when from F to E.

8. Enter the end angle of the arc (ED ANG)

This determines the position of the last cut feed in the processing of circular arc. As shown in Fig. (b), the end angle is 90° if the arc is to be processed from Point E to Point F, but 0 when from F to E.

9. Determine inner/outer circle mode:

For outer circular arc, as shown in Fig. (b), RAD+TL.
 For inner circular arc, as shown in Fig. (c), RAD -TL.

10. Move the machine tool to the start point of the processing in following with the display on axes, and then start the point by point processing.

11. You can quit the Arc R Calculation function as will, just key  .

(I) *Take the processing of the arc shown in the figure in page 22 as an example.

1) At first, finish tool setting, reset, key  , and enter ARC function.

2)choose smooth function

press 

press 







(only 2V readout has this set item and 3V readout has only smooth R function, so hasn't the set item and directly get into next step)

3) Select processing plane

Key  or 





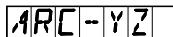





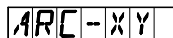

4) Select Plane XY

Key 



5) Enter the position of the circle center.

If finish the tool setting as shown in Fig. (a).

Key  →  →  →  →  → 

     







B. Smooth R(Be the same with: MIIL_MS 、 MIIL_M)

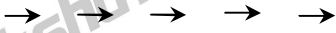

Key \downarrow

If finish the tool setting as shown in Fig. (b).

Key \times → 2 → 2 → \odot → 5 → \pm → ENT

\uparrow Y → 2 → 2 → \odot → 5 → \pm → ENT

Key \downarrow

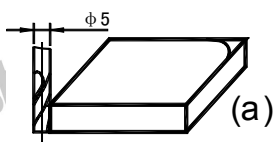
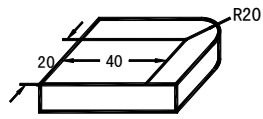

(a)

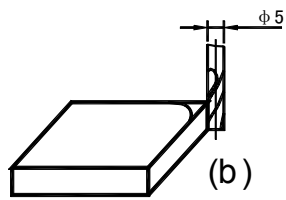

(b)

6) Enter the radius of the circle.

Key 2 → 0 → ENT

Key \downarrow



7) Enter the diameter of the tool.

Key 5 → ENT

Key \downarrow

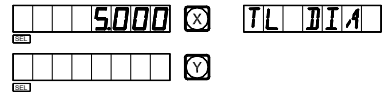

8) Enter the maximal cut.

Key 1 → ENT

Key \downarrow

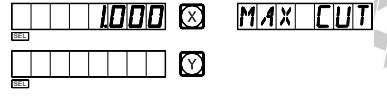

9) Enter the start angle of the arc.

Key 0 → ENT

Key \downarrow



10) Enter the end angle of the arc.

Key 9 → 0 → ENT

Key \downarrow

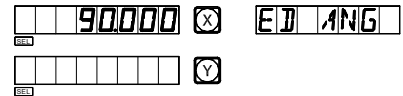

11) Determine inner/outer circle mode.

Key  or 

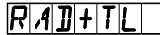

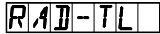

Key 



Key 

12) It is display that the processing start at the first point.

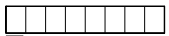
Tool setting as Fig. (a)

Tool setting as Fig. (b)



  

13) Move the machine tool to bring the display value on X- and Y-axes into zero, reach the start point of R.

 

14) Key  or  and the position of any processing point may come to be displayed, and you can move the machine tool to bring the displayed values on the both axes into zero and reach the position of the corresponding point of the R circular arc.

(II) *Take the processing of the arc shown in the figure in page 24 as an example again.

1) At first, finish tool setting, reset, key  , and enter ARC function.

2) choose smooth function

press 

press 







(only 2V readout has this set item and 3V readout has only smooth R function, so hasn't this set item and directly get into next step)

3) Select processing plane

Key  or 

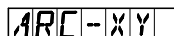

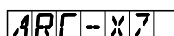

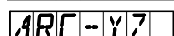

4) Select Plane XZ.

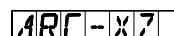

Key

5) Enter the position of the circle center.
If you use a circular arc milling tool,

Key → → → → →

→ → → → →

Key

If you use a circular arc milling tool,

Key → → → → →

→ → → → →

Key

If you use a flat end milling tool,

Key → → →

→ →

Key

If you use a flat end milling tool,

Key → →

→ →

Key

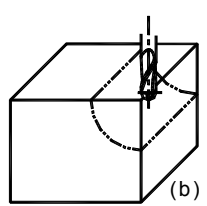
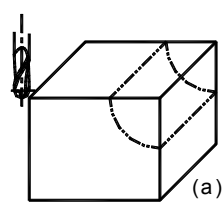
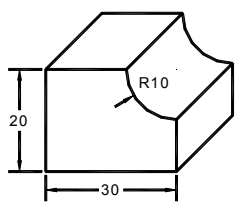

6) Enter the radius of the circle.

Key → →

Key

7) Enter the diameter of the tool.

Use a circular arc milling tool

Key **5** → **ENT**

Use a flat end milling tool

Key **0** → **ENT**

Key **↓**

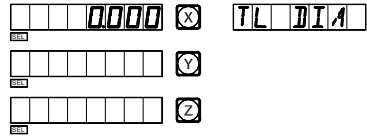

8) Enter the maximal cut.

Key **1** → **ENT**

Key **↓**

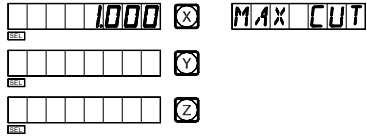

9) Enter the start angle of the arc.

Key **2** → **7** → **0** → **ENT**

Key **↓**

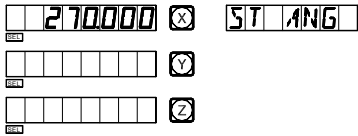

10) Enter the end angle of the arc.

Key **1** → **8** → **0** → **ENT**

Key **↓**

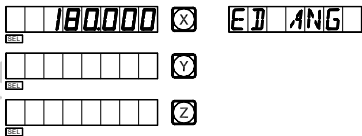

11) Determine inner/outer circle mode.

Key **↑** or **↓**

Key **ENT**

Key **↓**

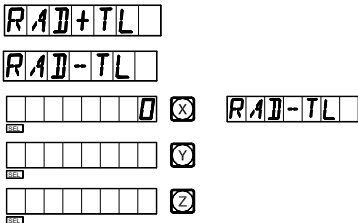

12) It is display that the processing start at the first point.

Use a circular arc milling tool setting as Fig. (a)

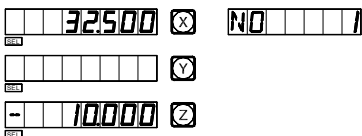

Use a circular arc milling tool setting as Fig. (b)

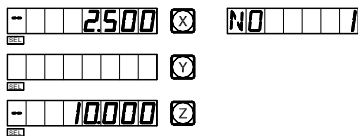

Use a flat end milling tool

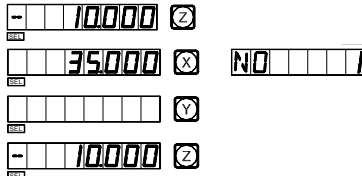

setting as Fig. (a)

Use a flat end milling tool setting as Fig. (b)

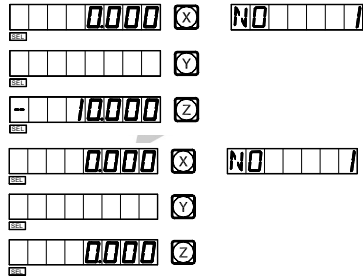

- 13) Move the machine tool to bring the display value on X- and Y-axes into zero, reach the start point of R.

- 14) Key or and the position of any processing point may come to be displayed, and you can move the machine tool to bring the display values on the both axes into zero and reach the position of the corresponding point of the R circular arc.

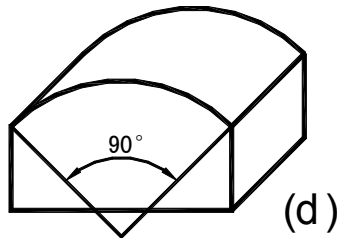
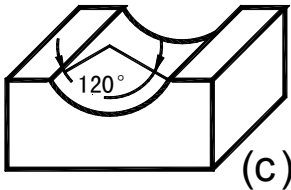

Note: When the arc to be processed in Planes XZ and YZ covers the 90° or the 270° position, for example, the one from 210° to 330° covers 270° in Fig.(c), and the other from 135° to 45° covers 90° in Fig. (d),end mill shall not be used.

(III) *Take the processing of the working piece shown in the figure on the right as the third example:

1. For the processing of this working piece, it is necessary to calculate out the start and end angles of the arc at first.

Refer to the figure.

$$\alpha = \arccos(17.3/2/10) \approx 30^\circ$$

The start angle (ST ANG)of the arc is 30°, and the end angle (ED ANG) is 150°.

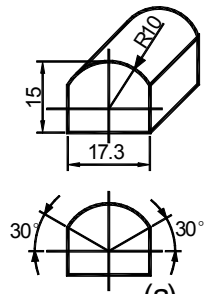

2. At first, finish tool setting and return the boring

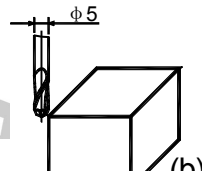

ring scales on X- and Z- axes to zero.

1) Key  , enter ARC function.

2) choose smooth function

press 

press 







(only 2V readout has this set item, 3V readout has only smooth R function, so hasn't this set item and directly get into next step)

3) Select processing plane.

Key  or 

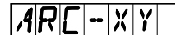

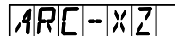

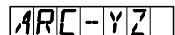

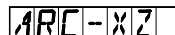







4) Select Plane XZ.

Key 

5) Enter the position of the circle center

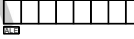

Key  →  →  →  →  →  →   ⊗ 

 →  →  →  →  →  →   ⊙

Key   ⊙



6) Enter the radius of the circle.

Key  →  →   ⊗ 

Key 

***Now a circular arc mill is used, finish the tool setting as shown in Fig. (b)**



7) Enter the diameter of the tool.

Key  → 

Key 

 ⊗ 

8) Enter the maximal cut.

Key  → 

Key 

 ⊗ 

9) Enter the start angle of the arc.

Key  →  →  → 



 ⊗ 

C.

Simple R

(Be the same with: 2V-MIIL_MS, 2V-MIIL_M)

Simple Arc R Calculation function:

One who is not quite at home in the concepts of plane coordinates will feel difficult in using smooth arc function. If the arc to be processed is simple enough, and the required smoothness is average, the simple arc R function may be a good choice.

In general, the processing of a circular arc will be realized in one of the eight ways shown below, using end mill or circular arc mill.

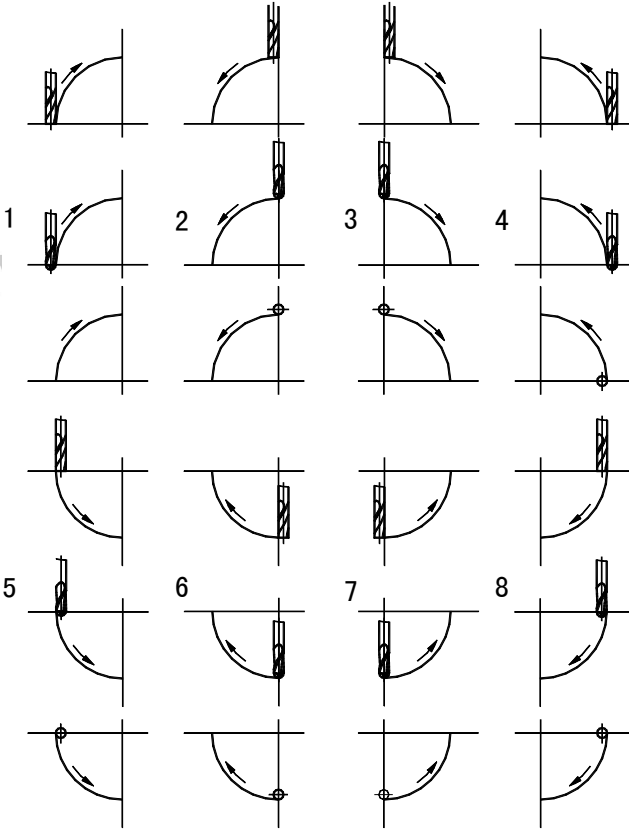

***The operation procedure of the simple arc R function.**

Let the tool face just at the arc, and key , enter arc R Calculating function. As to how to let the tool face just at the start point, just refer to (1) in page 30.

1. Select the simple R function (SIMPLE).
2. Select the processing way among the preset 1 to 8 ways, the prompt: "WHICH".
3. Select the processing plane, XY、 XZ or YZ.

- (ARC-XY)
- (ARC-XZ)
- (ARC-YZ)

4. Enter the of the circular arc (RDDIUS)
5. Enter the diameter of the tool (TL DLA): When processing the arc in Planes XZ and YZ, end mill is used and the processing in carried by the end edge of the tool, so the diameter valve to be entered should be zero.(refer to step 5 in the operation procedure of the smooth R function).
6. Enter the maximal cut (MAX CUT):

When processing an arc in Planes XZ and YZ, "MAX CUT" in the simple R function is defined as the depth of cut in each cut feed in Z axis direction (see Fig. a) the maximal cut can be changed during the processing.

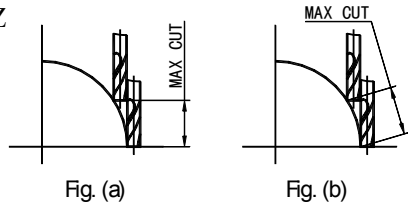

When processing an arc in plane XY, "MAX CUT" is the cut of each cut feed and is uniform (refer to Fig. b).

7. Implement the processing point by point following the display.

8. You may quit the arc R Calculating function at will, just key F10

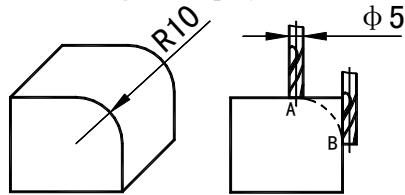

***Take the processing of the arc on right as an example.**

- 1) At first, let the tool face just at the start point of the arc (point A or Point B), key F10, enter ARC function.
Select the simple function key F11.

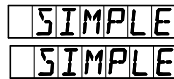

- 2) Select R processing mode.

Start point is A, key → F12

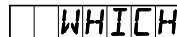

End point is B, key → F12

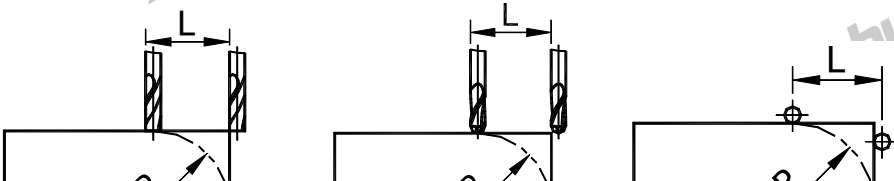

$L = R$

$L = R + \text{the radius of the tool}$

$L = R + \text{the radius of the tool}$

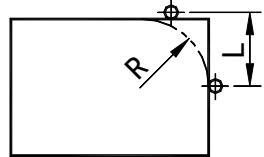
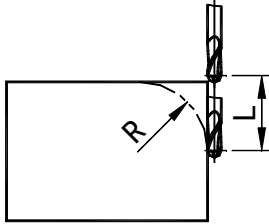
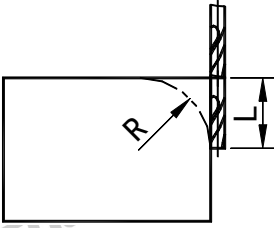

$L = R$

$L = R + \text{the radius of the tool}$

$L = R + \text{the radius of the tool}$

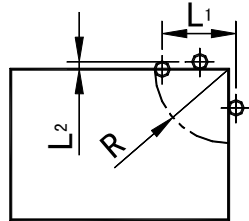
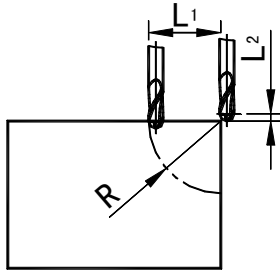
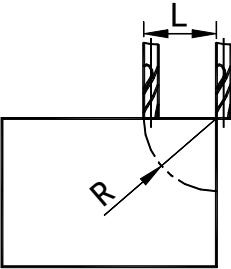

$L = R$

$L1 = R$
 $L2 = \text{the radius of the tool}$

$L1 = R$
 $L2 = \text{the radius of the tool}$

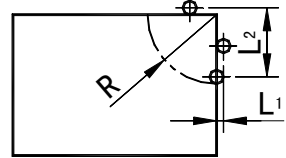
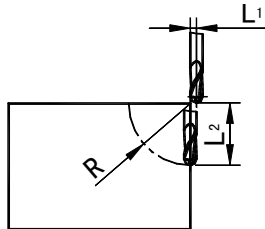
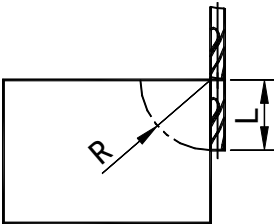

$L = R$

$L1 = \text{the radius of the tool}$
 $L2 = R$

$L1 = \text{the radius of the tool}$
 $L2 = R$

End mill

Circular arc mill

Plane XY

3) Select the processing plane

Key $\text{\textcircled{X}}$ or $\text{\textcircled{Y}}$

ARC-XY

ARC-XZ

4) Select Plane XZ

Key

ARC-YZ

ARC-XZ

5) Enter the radius of the circular arc

Key → →

RADIUS

Key

RADIUS

6) Enter the radius of the tool

Key →

TL DIA

Key

7) Enter the maximal cut

Key → → →

MAX CUT

Key

8) Start processing

Key

+

Point A as the start point(0,0)

Key

X Y Z 2

Point B as the start point(0,0)

Key

X Y Z 2

9) Refer to the display, move the machine tool to bring the displayed value on X axis into zero, then turn the Z axis star wheel to let the machine table rise or drop by the display value in Y axis.

10) Key or and the position of next/last point will displayed.

You can quit ARC function at will, just

key

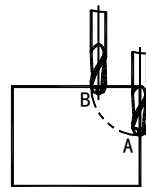
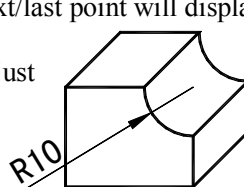



*Take the processing of an inner circular arc as example:

- 1) At first, align the tool to face just the start point(Point A or Point B),
key  to enter ARC function.



 SIMPLE

Select the simple function, key 

- 2) Select the way of the R processing

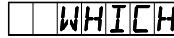
Point A is the start point, key  → 

 WHICH

Point A is the start point, key  → 

- 3) Select the processing plane

Key  or 

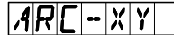
 ARC-XY

 ARC-XZ

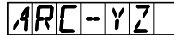

 ARC-YZ

- 4) Select Plane XZ

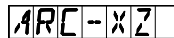
Key 

 ARC-XZ



- 5) Enter the radius of the circular arc

Key  →  → 

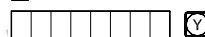

 RADIUS

Key 

 10000  RADIUS



 

- 6) Enter the diameter of the tool





Key  → 



 5000  TL DIA

Key 



 

- 7) Enter the maximal cut

Key  →  →  → 

 0500  MAX CUT

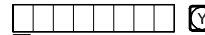
Key 

 

- 8) Enter processing mode



Key 

 0000  + 0000

 0000 

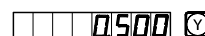

Point A is the start point(0,0), key 

 - 2690  X Y Z 2

 0500 

Point A is the start point(0,0), key 

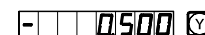
 0075  X Y Z 2

 - 0500 

- 9) Refer to the display, move the machine tool to bring the displayed valve on X axis into zero, then turn the Z axis star wheel to let the machine table rise or

drop by the displayed value in Y axis.

- 10) Key or and the position of next/last point will display. You may quit ARC function, just key .

Note: After entering processing mode, the number of the processing point and the accumulated value in Z axis direction will alternately displayed on the message window.

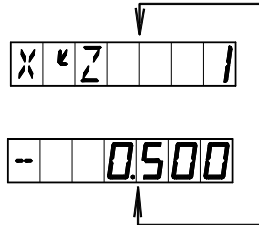

***Changing the maximal cut**

When processing an arc in Plane XZ and YZ, “MAX CUT” is the depth of cut in Z axis. If the depth of cut in Z axis is uniform, the surface quality of the arc worked out will be very no uniform. In order to improve the surface quality of the circular arc processing in Plane XZ and YZ, the operator may change the maximal cut during the processing to bring a rather uniform surface quality. When processing an arc in Plane XY, “MAX CUT” is the cut of each cut feed. By reason of the cut of each cut feed in uniform, the surface quality of the arc worked out will be controlled to be rather uniform, so, no “changing the maximal cut” function will be used when processing an arc in Plane XY.

For changing the maximal cut, the operator may follow the following operations.

- 1) Change the maximal cut under processing mode.

Key

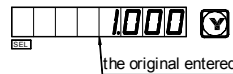

- 2) Enter the changed value of the maximal cut, for example, “0.5”.

Key → → →



- 3) Return to processing mode, Continue the processing.

Key



D.

Hole Drilling Along An Oblique Line

(Be the same with: MIIL_MS)

The function of hole drilling along an oblique line

Normally, for processing the working pieces shown in the right figure the operator must calculate out the distance between two neighboring holes in X- and Y- axes; an easy and quick resolution is provided through the function of hole drilling along an oblique line.

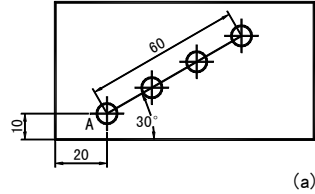

(a)

What the operator shall do is only entering the following data:

The length of the oblique line(LENGTH)

This is the real distance from the center of the start hole to the center of the end hole, enter this data when “MODE L” (length mode) is selected.

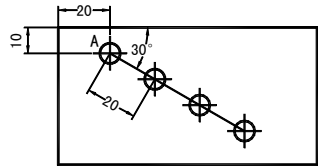

(b)

The step length (STEP)

This is the distance between two neighboring holes.

This data shall be entered when “MODE S” (step length mode) is selected.

Angle (ANGLE)

This is the direction of the oblique line in the plane coordinate. The angle is 30° in (a), so, the plane angle to be entered is 30; the angle is -30 in (b), so the plane angle to be entered is -30.

Number of holes (NUMBER)

Take the processing of (a) as example

- 1) At first move the tool to the position of the start hole A.
Key to enter the function.

- 2) Choosing the processing plane

Press or

Choose “processing plan”, press

(only 3V readout has this set item, 2V readout has only XY plane, so needn't choose plane and can directly get into next step)

- 3) Select Mode

Key or

Select “MODE L”

Key

- 4) Enter the length of the oblique line

Key **6** → **0** → **ENT**
 Key **↓**

5) Enter the angle

Key **3** → **0** → **ENT**

30000 **×** **ANGLE**

Key **↓**

6) Enter the number of holes

Key **4** → **ENT**

4 **×** **NUMBER**

Key **↓**

7) The position of the first hole is displayed, enter processing state.

0000 **×** **NO**

0000 **Y**

8) Key **↓** to display the position of next processing point, and then move the machine tool to bring the displayed value on both X- and Y-axes into zero. You can quit the function at will, just key **↩**.

For the working piece in (a), it is more convenient to select “MODE L”. In the following, we take working piece in (b) as another example to show how to operate when “MODE S” is selected.

1) At first move the tool to the position of the start hole A.

Key **↩** to enter the function

2) Choosing the processing plan

LINE XY

Press **↑** or **↓**

Choose “processing plan”, press **ENT**

(only 3V readout has this set item, 2V readout has only XY plane so needn't choose plane and can directly get into next step)

3) Select Mode

MODE L

Key **↑** or **↓**

MODE S

Select “MODE S”

MODE S

Key **ENT**

4) Enter the step length



20000 **×** **STEP**

D. Hole Drilling Along An Oblique Line(Be the same with: MILL_MS)

Key  →  → 

Key 



5) Enter the angle

Key  →  → 

Key 

6) Enter the number of holes

Key  → 



  

Key 

7) Enter processing state

8) Key  to display the position of next processing point, and then move the machine tool to bring the displayed value on both X- and Y-axes into zero. You can quit the function at will, just key .

E₁

The Function For 200 Point Subsidiary Zero Positions

(Be the same with: MIIL_MS、MIIL_M、EDM)

200 subsidiary zero position function:

200 auxiliary zero position function: also is called 200 user Coordinate System (UCS) function.

ALE: Absolute Coordinate System.

ALE is the “reference” system. All 200 UCS are defined relative to the ALE. ALE is confirmed in the initialization of the work piece process, which doesn’t change if the work piece no changed.

UCS: User Coordinate System.

In the processing of moulds, often it would not work with only one reference zero position, normally, a lot of subsidiary zero positions is necessary. In the processing of a large of complicated drilling/milling fittings with multi point dimensions, it is also necessary to have a lot of fixed point positions in order to perform the processing of a series of structures with dimensions referred to these point position. In these cases, if there is only one reference point, the working efficiency will be rather low, as you have to find out the correct position point by point, more over, it may be very difficult for complicated moulds or moulding fittings to do in such a way. The function 200 point subsidiary zero positions is specially provided as a good resolution for this problem.

I . The operator must know the following two key points before making use of this function:

1. Every subsidiary zero position is equivalently the original point of one UCS. Once entering the display mode of such UCS, the display of every point will take the subsidiary zero position as the original point.
2. There is relation between every subsidiary zero position and the zero position is the absolute mode. After a subsidiary zero position is set, it will keep the position relation between it and the zero position in the absolute mode in memory, once the zero position in the absolute mode changes, the subsidiary zero position will also change by the same distance and angle.

II . The operator may fully make use this function as the following:

1. Set the zero position in absolute mode (ALE lamp on) at the main reference point of the working piece, for example, Point O in Fig. (1) in next page. Set subsidiary zero positions at subsidiary reference points of the working piece, for example, Points 1, 2 and 3 in Fig. (1). It is possible to enter the display mode of every UCS taking a subsidiary zero position as its original points to perform the processing when need.

2. In the display mode of every UCS, processing with various special function can be performed.

III. The setting of subsidiary zero position

There are two methods of setting subsidiary zero position: the one is entering the position of the subsidiary zero position directly, the other is resetting once a subsidiary zero position is reached.

Method 1: Directly Entering, under the UCS display mode, key X Y Z

→ Number keys → ZERO .

Take Fig. (1) as example: After turning the machine on, move the machine tool to the center point O in Fig.(1), enter the absolute display mode.

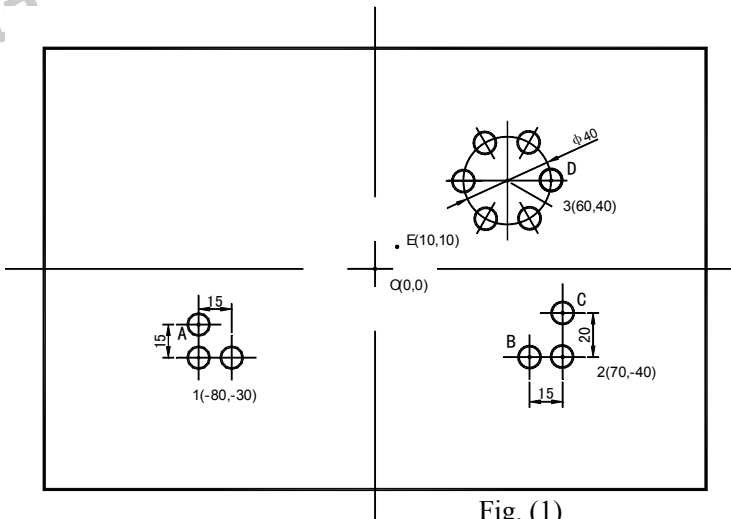
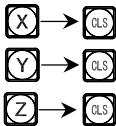

Fig. (1)

Reset, set the zero position in the absolute mode at the main reference of the working piece.



1) After setting the zero position in the absolute mode, the system automatically perform a keeping in memory operation, in order that once a power interruption happen in the course the zero position may be tracked back.

2) Enter the UCS display mode. (Two Method)

Method 1:

Key

INC

Key

ZER

Method 2:

Key

ZERO NO

Key →

ZER

3) Enter the position of the first subsidiary zero position.

Key → → → →

80000

ZER

→ → → →

30000

4) Enter the position of the second UCS.

Key or

ZER

Key →

5) Enter the position of the second zero position.

Key → → →

70000

ZER

→ → → →

40000

6) Enter the display mode of the third UCS.

Key or

ZER

Key →

7) Enter the display mode of the third zero position.

Key → → →

60000

ZER

→ → →

40000



The setting of all the subsidiary zero positions of the working piece shown in Fig. (1) has been finished.

Why the enter position coordinates of every subsidiary zero position are just in the opposite direction of the displayed values? Let us explain this with the above example. Under the UCS mode, when the coordinates of the subsidiary zero position are entered at the position of the zero position in the absolute mode, the displayed data will be the position of the zero position in the absolute mode in the corresponding UCS. This is because the subsidiary zero position is taken as the original point of the UCS under the relative display mode. In Fig. (1), we can see that Point O is at the position(-80, -30) with respect to Point 1, (-70, -40) with respect to Point 2, and (-60, -40)with respect to Point 3. If the operator enter the coordinates of a subsidiary zero point other than the zero position in the absolute mode, the displayed data will be the position with respect to subsidiary zero point in the corresponding UCS. For example, when the position of the third subsidiary zero position is entered at Point E, the resulted display will be (-50, -30).

Method 2: Clearing when the position is reached. When the machine tool is at the position of the subsidiary zero point, key → .

We take the working piece shown in Fig. (1) as example again: Move the machine table to the center point O shown in Fig. (1).

1) Enter the absolute display mode, reset, set the zero position in the absolute mode at the main reference point.

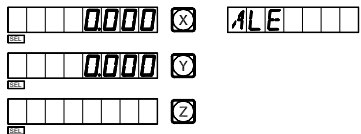

2) Move the machine table of the machine tool to Point 1.
X axis display -80,
Y axis display -30,

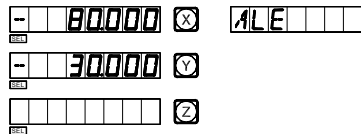

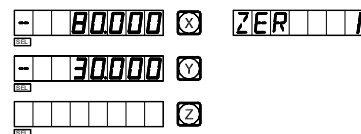

3) Enter the display mode of the first UCS.

Key or
 Key →



4) Set the subsidiary zero position.

Key  → 

 → 

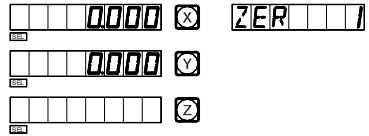

5) Return to the absolute state display mode

Key 

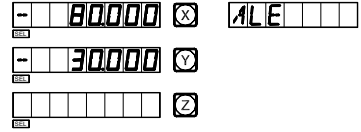



6) Move the machine table of the machine tool to Point 2.

X axis display 70,

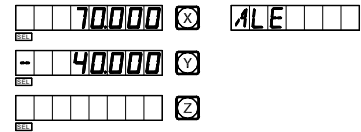
Y axis display-40.





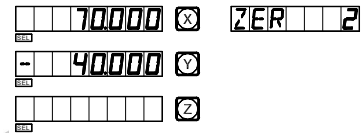

7) Enter the display mode of the second UCS.

Key  →  → 



8) Clear, set the second subsidiary zero point.

Key  → 

 → 

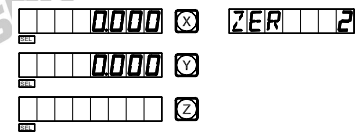

9) Return to the absolute state display mode.

Continue to touch three times key 





10) Move the machine table of the machine tool to Point 3.

X axis display 60,

Y axis display 40.



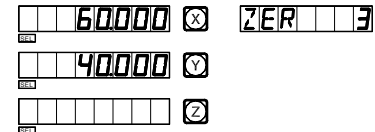

11) Enter the display mode of the third UCS.

Key  →  → 



12) Clear, set the third subsidiary zero point.

Key  → 

 → 

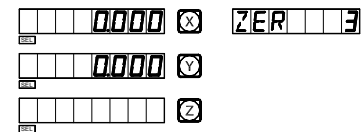

13) Return to the absolute state display mode.

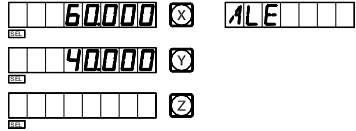

Continue to touch four time key 









The setting of all the subsidiary zero positions of the working piece shown in Fig. (1) has been finished.

IV. The usage of subsidiary zero positions.

After entering the display mode of the UCS, the corresponding subsidiary zero positions may be used to help in the processing.

It is possible to enter a UCS display mode using key 、 or .

When using keys  and , you may key  or  continuously until entering the desired UCS.

When using key  just key  and under the prompt “ZERO No” enter the number of the desired UCS. For the related operations, the operator may refer to “5 Absolute/relative/user coordinate display mode” under “ I .Usage” of “A. Basic Function”.



We take the working piece shown in Fig. (1) as example.

1) Enter the display mode of the first UCS.

Key 



2) Enter the number.

Key  → 

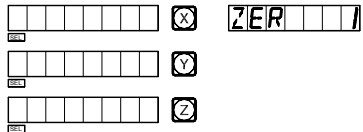

3) Move the machine tool to Point A.

X axis display 0,
Y axis display 15.

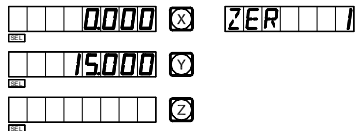

4) Process Hole A.

5) Enter the display mode of the second UCS.

Key 

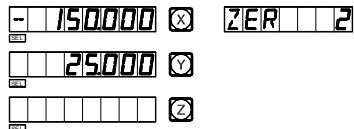

6) Move the working of the machine tool to Point B

X axis display -15,
Y axis display 0.

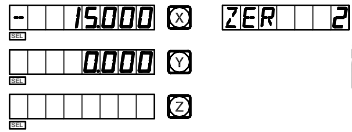

7) Process Hole B

8) Move the machine tool to Point C.

X axis display 0,
Y axis display 20.

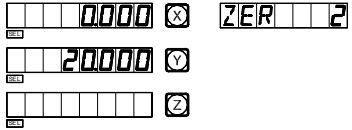

9) Process Hole C

10) Enter the display mode of the third UCS.

Key

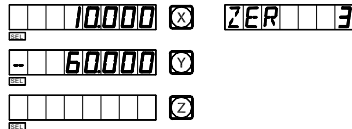

11) Move the machine tool to point 3.

X axis display 0,
Y axis display 0.

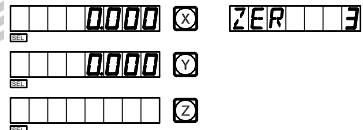

12) Enter PCD function, process the six small

holes distribute uniformly on the circle

center at Point 3.

Key

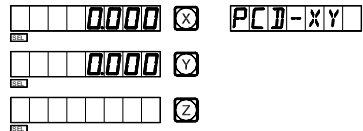

13) The processing of the six small holes has been

finished, return to Point D, the display should be:

For PCD function, please refer to the related sections.

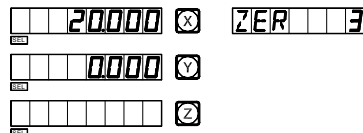

V. The Clearing of Subsidiary Zero Positions and Other Related Problems.

1. The Clearing of Subsidiary zero positions

In absolute state (ALE state), key  10 times continuously, the memory about all the subsidiary zero positions will be cleared, the 200 subsidiary zero positions will become the same point of the zero position in the absolute state.

2. Reset during a subsidiary zero position is being used

A subsidiary zero position is being used of course under the display mode of the corresponding UCS, resetting in this state is actually to reset a new subsidiary zero position. The point at which the resetting operation act become the new subsidiary zero position, and the new subsidiary zero position replacing the original subsidiary zero position.

3. Turn to one half during a subsidiary zero position is being used

“1/2” function may be used under UCS display mode. Turning to one half under the UCS display mode using a subsidiary zero position is actually also resetting a new subsidiary zero position. After the operation of turning to one half act, the original subsidiary zero position will be replaced by the new subsidiary zero position is center between the original subsidiary zero position and the point at which the operation act.

E₂

**The Function For 200 Point
Subsidiary Zero Positions**

(Be the same with: LATHE)

200 subsidiary zero position function:

200 auxiliary zero position function: also is called 200 user Coordinate System(UCS) function.

ALE: Absolute Coordinate System.

ALE is the “reference” system. All 200 UCS are defined relative to the ALE. ALE is confirmed in the initialization of the work piece process, which doesn't change if the work piece no changed.

UCS: User Coordinate System.

In the processing of moulds, often it would not work with only one reference zero position, normally, a lot of subsidiary zero positions is necessary. In the processing of a large or medium lot of complicated drilling/milling fittings with multi point dimensions, it is also necessary to have a lot of fixed point positions in order to perform the processing of a series of structures with dimensions referred to these point position. In these cases, if there is only one reference point, the working efficiency will be rather low, as you have to find out the correct position point by point, more over, it may be very difficult for complicated moulds or molding fittings to do in such a way. The function 200 point subsidiary zero positions is specially provided as a good resolution for this problem.

I . The operator must know the following two key points before making use of this function.

1. Every subsidiary zero position is equivalently the original point of one UCS. Once entering the display mode of such UCS, the display of every point will take the subsidiary zero position as the original point.
2. There is relation between every subsidiary zero position and the zero position is the absolute mode. After a subsidiary zero position is set, it will keep the position relation between it and the zero position in the absolute mode in memory, once the zero position in the absolute mode changes, the subsidiary zero position will also change by the same distance and angle.

II . The operator may fully make use this function as the following:

1. Set the zero position in absolute mode (ALE lamp on) at the main reference point of the working piece, for example, Point O in Fig. (1) in next page. Set subsidiary zero positions at subsidiary reference points of the working piece, for example, Points 1、 2 and 3 in Fig. (1). It is possible to enter the display mode of every UCS taking a subsidiary zero position as its original points to perform the

processing when need.

2. In the display mode of every UCS, processing with various special function can be performed.

III. The setting of subsidiary zero position

There are two methods of setting subsidiary zero position: the one is entering the position of the subsidiary zero position directly, the other is resetting once a subsidiary zero position is reached.

Method 1: Directly Entering, under the UCS display mode, key $\boxed{X}\boxed{Y}\boxed{Z}$ → Number keys → \boxed{ZERO} .

Take Fig. (1) as example: After turning the machine on, move the machine tool to the center point O in Fig.(1), Enter the absolute display mode.

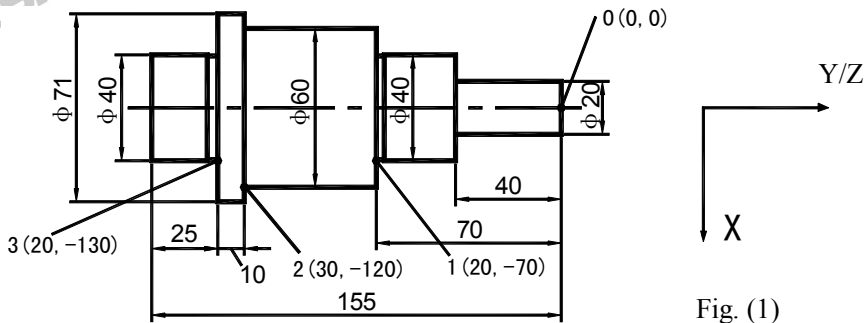
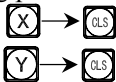

Fig. (1)

In the following content take Y axis as an example

Reset, set the zero position in the absolute mode at the main reference of the working piece.



1) After setting the zero position in the absolute mode, the system automatically perform a keeping in memory operation, in order that once a power interruption happen in the course the zero position may be tracked back.

2) Enter the UCS display mode. (Two Method)

Method 1:

Key $\boxed{\uparrow}$

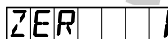
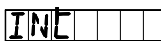

Key

Method 2:

Key
 Key →

3) Enter the position of the first subsidiary zero position.

Key → → →
 → → → →

4) Enter the position of the second UCS.

Key or
 Key →

5) Enter the position of the second zero position.

Key → → →
 → → → → →

6) Enter the display mode of the third UCS.

Key or
 Key →

7) Enter the display mode of the third zero position.

Key → → →
 → → → → →

The setting of all the subsidiary zero positions of the working piece shown in Fig. (1) has been finished.

Why the direction of each coordinate of your input auxiliary zero position opposite to that of the display result? As the above example illustrates, under the user coordinate display mode, if you enter the coordinate of auxiliary zero

position on the position of the zero position under absolute state, the display result will be the position of absolute state zero position in this user coordinate. Because the user coordinate display mode uses each auxiliary zero position as the origin of user coordinate. Seeing from Fig. 1, Point O is exactly located at the position of Point 1(-20, 70), the position of Point 2 (-30, 120) and that of to Point 3 (-20, 130). If the operator enters the coordinate of auxiliary zero point at any other point than the zero point under absolute state, the display result will be the position of this point in this user coordinate.

Method 2: Clearing when the position is reached. When the machine tool is at the position of the subsidiary zero point, key $\boxed{X} \boxed{Y} \rightarrow \boxed{CLS}$.

Method 2 is not suited to operations on lathe. The instructions for lathe are not given in details in this manual.

IV. The usage of subsidiary zero positions.

After entering the display mode of the UCS, the corresponding subsidiary zero positions may be used to help in the processing.

It is possible to enter a UCS display mode using key $\boxed{\uparrow}$ 、 $\boxed{\downarrow}$ or \boxed{ZERO} .

When using keys $\boxed{\uparrow}$ and $\boxed{\downarrow}$, you may key $\boxed{\uparrow}$ or $\boxed{\downarrow}$ continuously until entering the desired UCS.

When using key \boxed{ZERO} just key \boxed{ZERO} and under the prompt “ZERO No” enter the number of the desired UCS. For the related operations, the operator may refer to “5 Absolute/relative/user coordinate display mode” under “ I .Usage” of “A. Basic Function”.

Take the spare part shown in Processing Fig. (2) as an example, operator can use the 200 point auxiliary zero-point function in grinding and turning.

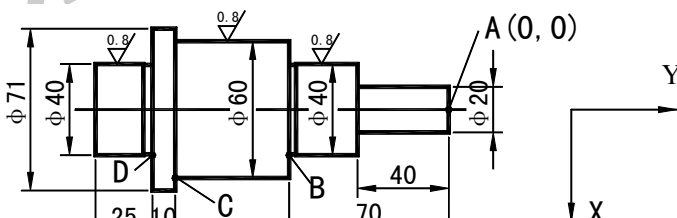

Fig.(2)

The work piece has been roughly turned, and has to be semi subtly turned.

The unilateral allowance through rough turning is 0.05, the subtle turning will the surface of the work piece to meet the roughness requirements.



First set the absolute coordinate origin at Point A, then directly the position of the auxiliary zero point according to the setting method I for auxiliary zero point to set up the user coordinate system. We have set the first auxiliary zero point at the point (10, -40), the second at the point (20.05, -70) and the point (30.05, -120).

1) After checking the cutting tool, enter the first user coordinate system.

Key 

ZERO NO

2) Enter the code

Key  → 

  ZRE 

3) Process the encircle $\Phi 20$

Start cutting until the displays on both X axis and Y turn out 0.

 0000  ZER  1
 0000 

4) Enter the second user coordinate system.

Key 

-  10050  ZER  2
 30000 

5) Process the encircle $\Phi 40$

start cutting until the displays on X axis and Y turn out 0.

 0000  ZER  2
 0000 

6) Enter the third user coordinate system.

- 00000 (X) ZER 0003
 50000 (Y)

Key 

7) Process the encircle $\Phi 60$

00000 (X) ZER 0003
 00000 (Y)

Start cutting until the displays on X axis and Y turn out 0.

8) Return to absolute state

Keep pressing  until "ALE" is displayed.

30000 (X) ALE 0000
 - 120000 (Y)

9) Switch the work piece to the other side of its, for turning of such other end encircle $\Phi 40$.

V. The Clearing of Subsidiary Zero Positions and Other Related Problems.

1. The Clearing of Subsidiary zero positions

In absolute state (ALE state), key  10 times continuously, the memory about all the subsidiary zero positions will be cleared, the 200 subsidiary zero positions will become the same point of the zero position in the absolute state.

2. Reset during a subsidiary zero position is being used

A subsidiary zero position is being used of course under the display mode of the corresponding UCS, resetting in this state is actually to reset a new subsidiary zero position. The point at which the resetting operation act become the new

subsidiary zero position, and the new subsidiary zero position replacing the original subsidiary zero position.

3. Turn to one half during a subsidiary zero position is being used

“1/2” function may be used under UCS display mode. Turning to one half under the UCS display mode using a subsidiary zero position is actually also resetting a new subsidiary zero position. After the operation of turning to one half act, the original subsidiary zero position will be replaced by the new subsidiary zero position is center between the original subsidiary zero position and the point at which the operation act.

E₃

**The Function For 200 Point
Subsidiary Zero Positions
(Be the same with: 2V-GRIND)**

200 subsidiary zero position function:

200 auxiliary zero position function: also is called 200 user Coordinate System (UCS) function.

ALE: Absolute Coordinate System.

ALE is the “reference” system. All 200 UCS are defined relative to the ALE. ALE is confirmed in the initialization of the work piece process, which doesn’t change if the work piece no changed.

UCS: User Coordinate System.

In the processing of moulds, often it would not work with only one reference zero position, normally, a lot of subsidiary zero positions is necessary. In the processing of a large of complicated drilling/milling fittings with multi-point dimensions, it is also necessary to have a lot of fixed point positions in order to perform the processing of a series of structures with dimensions referred to these point position. In these cases, if there is only one reference point, the working efficiency will be rather low, as you have to find out the correct position point by point, more over, it may be very difficult for complicated moulds or moulding fittings to do in such a way. The function 200 point subsidiary zero positions is specially provided as a good resolution for this problem.

I . The operator must know the following two key points before making use of this function:

1. Every subsidiary zero position is equivalently the original point of one UCS. Once entering the display mode of such UCS, the display of every point will take the subsidiary zero position as the original point.
2. There is relation between every subsidiary zero position and the zero position is the absolute mode. After a subsidiary zero position is set, it will keep the position relation between it and the zero position in the absolute mode in memory, once the zero position in the absolute mode changes, the subsidiary zero position will also change by the same distance and angle.

II . The operator may fully make use this function as the following:

1. Set the zero position in absolute mode (ALE lamp on) at the main reference point of the working piece, for example, Point O in Fig. (1) in next page. Set subsidiary zero positions at subsidiary reference points of the working piece, for example, Points 1, 2 and 3 in Fig. (1). It is possible to enter the display mode of every UCS taking a subsidiary zero position as its original points to perform the processing when need.

2. In the display mode of every UCS, processing with various special function can be performed.

III. The setting of subsidiary zero position

There are two methods of setting subsidiary zero position: the one is entering the position of the subsidiary zero position directly, the other is resetting once a subsidiary zero position is reached.

Method 1: Directly Entering, under the UCS display mode, key \boxed{X} \boxed{Y} → Number keys → \boxed{ZERO} .

Take Fig. (1) as example: After turning the machine on, move the machine tool to the center point O in Fig.(1), Enter the absolute display mode.

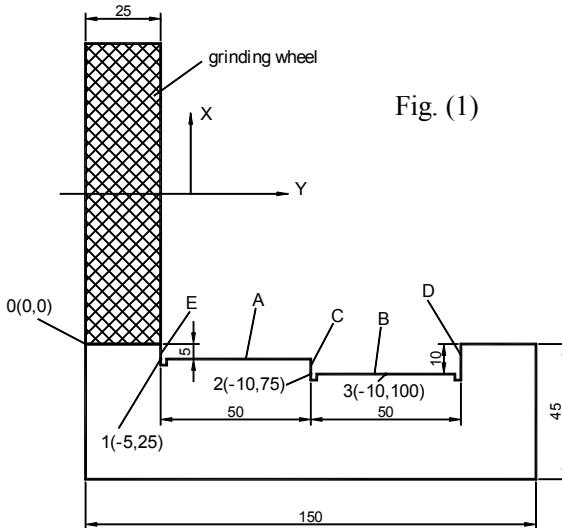
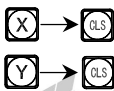

Fig. (1)

Reset, set the zero position in the absolute mode at the main reference of the working piece.



1) After setting the zero position in the absolute mode, the system automatically perform a keeping in memory operation, in order that once a power interruption happen in the course the zero position may be tracked back.

2) Enter the UCS display mode. (Two Method)

Method 1:

Key 

INCL



Key 

ZER

Method 2:

Key 

ZERO NO





Key  → 

ZER

3) Enter the position of the first subsidiary zero position.

Key  →  →  → 

50000 X ZRE



 →  →  → 

25000 Y





4) Enter the position of the second UCS.

Key  or 





ZER

Key  → 

5) Enter the position of the second zero position.

Key  →  →  →  → 

10000 X ZRE



 →  →  → 

75000 Y





6) Enter the display mode of the third UCS.

Key  or 





ZER

Key  → 

7) Enter the display mode of the third zero position.

Key  →  →  →  → 

10000 X ZRE

 →  →  →  → 

100000 Y

The setting of all the subsidiary zero positions of the working piece shown in Fig. (1) has been finished.

Why the direction of each coordinate of your input auxiliary zero-position opposite to that of the display result? As the above example illustrates, under the user coordinate display mode, if you enter the coordinate of auxiliary zero position on the position of the zero position under absolute state, the display result will be the position of absolute state zero position in this user coordinate. Because the user coordinate display mode uses each auxiliary zero position as the origin of user coordinate. Seeing from Fig. 1, Point O is exactly located at the position of Point 1(5, -25), the position of Point 2 (10, -75) and that of to Point 3(10, -100). If the operator enters the coordinate of auxiliary zero point at any other point than the zero-point under absolute state, the display result will be the position of this point in this user coordinate.

Method 2: Clearing when the position is reached. When the machine tool is at the position of the subsidiary zero point, key → .

Method 2 is not suited to operations on grinding machine. The instructions for lathe are not given in details in this manual.

IV. The usage of subsidiary zero positions

After entering the display mode of the UCS, the corresponding subsidiary zero positions may be used to help in the processing.

It is possible to enter a UCS display mode using key , or .

When using keys and , you may key or continuously until entering the desired UCS.

When using key just key and under the prompt “ZERO No” enter the number of the desired UCS. For the related operations, the operator may refer to “5 Absolute/relative/user coordinate display mode” under “ I .Usage” of “A. Basic Function”.

We take the working piece shown in Fig. (1) as example again: Move the machine table to the center point O shown in Fig. (1).

1) Enter the display mode of the first UCS.

Key

ZERO NO

2) Enter the number.

Key →

| | | | | | | | | | | | |
|------|--|--|--|--|--|--|--|--|--|--|--|
| | | | | | | | | | | | |
| DISP | | | | | | | | | | | |

 ZRE

| | | | | | | | | | | | |
|------|--|--|--|--|--|--|--|--|--|--|--|
| | | | | | | | | | | | |
| DISP | | | | | | | | | | | |

| | | | | | | | | | | | |
|------|--|--|--|--|--|--|--|--|--|--|--|
| | | | | | | | | | | | |
| DISP | | | | | | | | | | | |

3) Process the plane A, E

Start grinding until the displays on both X axis and Y turn out 0.



4) Enter the second user coordinate system.

Key



5) Process the plane B, C

Start grinding until the displays on both X axis and Y turn out 0.



6) Enter the third user coordinate system.

Key



7) Process the plane B、 D

Start grinding until the displays on both X axis and Y turn out 0.



8) Return to absolute state

Keep pressing until “ALE” is displayed.



V. The Clearing of Subsidiary Zero Positions and Other Related Problems.

1. The Clearing of Subsidiary zero positions

In absolute state (ALE state), key 10 times continuously, the memory about all the subsidiary zero positions will be cleared, the 200 subsidiary zero positions will become the same point of the zero position in the absolute state.

2. Reset during a subsidiary zero position is being used

A subsidiary zero position is being used of course under the display mode of the corresponding UCS, resetting in this state is actually to reset a new subsidiary

zero position. The point at which the resetting operation act become the new subsidiary zero position, and the new subsidiary zero position replacing the original subsidiary zero position.

3. Turn to one half during a subsidiary zero position is being used

“1/2” function may be used under UCS display mode. Turning to one half under the UCS display mode using a subsidiary zero position is actually also resetting a new subsidiary zero position. After the operation of turning to one half act, the original subsidiary zero position will be replaced by the new subsidiary zero position is center between the original subsidiary zero position and the point at which the operation act.

F.

PCD Circle Equally Dividing Holes

(Be the same with: MIIL_MS、MIIL_M、EDM)

Circular arc equally Dividing Function(PCD Function)

This function may be used to divide a circular arc equally, for example in the processing of drilling holes distributed uniformly on a flange. After selecting this function, the message window will prompt for various parameters to be defined for the operator.

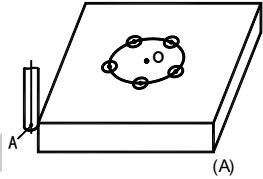

The following are parameter to be defined.

1. The position of the circle center.

The position of the circle center (CT POS) means the position of the circle center with respect to the center of the tool just after tool setting and clearing, such as the position of Point O with respect to Point A in Fig. (A).

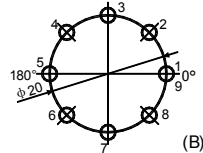

2. Diameter(DIA): The Diameter of the circle to be divided equally.

3. The number of holes(NUMBER):

The number of holes equally dividing the circle.

For the example shown in Fig. (B), 5 points from point 1 to Point 5 must be used to divide the arc from 0° to 180° into 4 equal sections. So, 9 points must be used to divide the whole circle into 8 equal sections, and Point 9 will coincide with Point 1. As shown in the Fig., in order to drill 8 hole on the circle into 8 sections, the number of point to be entered should be 9.

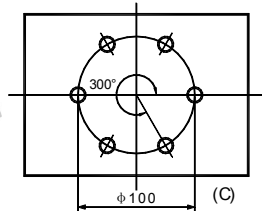

4. The start angle (ST ANG): The angle of the start point of the circular arc to be divide equally.

5. The end angle (ED ANG): The angle of the end point of the circular to be divided equally.

Note: For the definition of the start angle (ST ANG) and end angle (ED ANG), refer to the section “To recognize the start and end angle of a circular arc”, page 19.

Tale the processing of the circular working-piece in Fig. (c) as example:

1) At first, find out the center position of the working piece and finish tool setting reset.

Key  to enter PCD function.



2) Key or select processing plane.

PCD-XZ

or

PCD-YZ

Enter the parameter

Select Plane XY.

Key , next step.

PCD-XY

(only 3V readout has this set item, 2V readout has only XY plane, so hasn't the item and can directly get into next step)

3) Enter the center position of the circular arc.

Key → →

→ →

Key , next step.

CT POS

CT POS

4) Enter the diameter of the circular arc.

Key → → →

Key , next step.

5) Enter the number of points equally dividing the arc.

Fig. (c), we can consider it as 6 points is used to divide the arc from 0 to 300° into 5° equal section.

Key →

Key , next step.

NUMBER

NUMBER

It is also possible to consider as 7 points in points in used to divide the whole circle into 6 equal sections.

Key →

Key , next step.

NUMBER

6) Enter the start angle.

Key $\boxed{0} \rightarrow \boxed{ENT}$

Key $\boxed{\downarrow}$, next step.

ST ANG

\times ST ANG

7) Enter the end angle.

If the arc is dividing by 6 points.

Key $\boxed{3} \rightarrow \boxed{0} \rightarrow \boxed{0} \rightarrow \boxed{ENT}$

Key $\boxed{\downarrow}$, next step.

ED ANG

\times ED ANG

If the whole circle is divided by 7 point.

Key $\boxed{3} \rightarrow \boxed{6} \rightarrow \boxed{0} \rightarrow \boxed{ENT}$

Key $\boxed{\downarrow}$, next step.

\times ED ANG

8) Enter processing

The display result for dividing the arc into 5 equal sections.

The display result for dividing the arc into 6 equal sections.

\times NO

\times NO

9) Key $\boxed{\downarrow}$ and the position of next processing point will be displayed, just move the machine tool to bring the displayed values on both axes into zero to reach the corresponding processing position.

10) You may quit PCD function at will, just key $\boxed{\text{gear}}$.

G. Angular Surface Processing

(Be the same with: MIIL_MS)

Angular Surface Processing

When the processing of a rather large angular surface is one part of job, the angular processing function can make the job much easier.

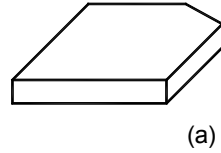

I . Aligning for the bank angle:

When the processing surface is Plane XY as in the case of the fitting shown in Fig. (a), it is necessary to align the working piece for the bank angle before processing the angular surface. In this case, the angular surface processing function plays its role in aligning the reference plane for the bank angle.



The procedure of aligning for the bank angle:

At first, set the working piece on the machine table with an oblique angle equal roughly the desired bank angle.

1. Key  to enter the angular surface processing function.
2. Select the processing plane-Plane XY.
3. Enter the angle of the angular surface (ANGLE).
4. Move the machine table to let the metering tool(for example, dial indicator) preset on the milling machine come just in contact with the reference plane being aligned, adjust the scale reading into zero, and move the machine table an arbitrary distance along X axis.
5. Key , refer to the display and move along Y axis until the displayed value become zero.
6. Adjust the angle of the working piece and bring the scale reading into zero.

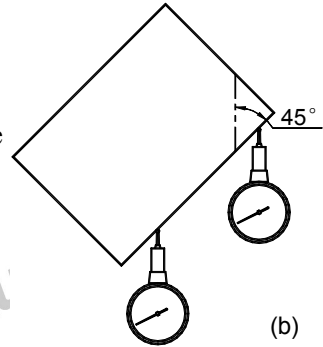

For example: Align the bank angle of the working piece to 45° as shown in Fig. (b).

- 1) Set the working piece on the machine table with a bank angle equal roughly 45°

Key 



LINE-XY

2) Select Plane XY.

Key 



LINE-XY

3) Enter the angle of the angle surface

Key  →  → 

Key 

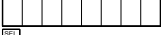

  ANGLE

4) Move the machine table along X axis.

Let the metering tool come just in contact with the working piece, and adjust the scale reading into zero, then move the machine table an arbitrary distance along X axis.

  MOVE X

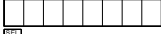
5) The moving distance on Y axis is displayed.

Key 

  MOVE Y

6) Move the machine tool along Y axis.

Adjust the bank angle of the working piece, let the reference plane being aligned come just in contact with the metering tool and the scale reading be zero.

7) Move the machine table to bring the displayed value on Y axis into zero.

You may quit the angular surface processing function at will, just key .

II. Processing the angular surface

When the processing plane is Plane XZ or YZ, the angular processing function may prompt in processing the angular surface step by step.

Processing on using the angular processing function:

When the processing plane is Plane XZ or YZ. At first align the spindle of the machine tool for the bank angle, finish tool setting, and key  to enter the angular processing function.

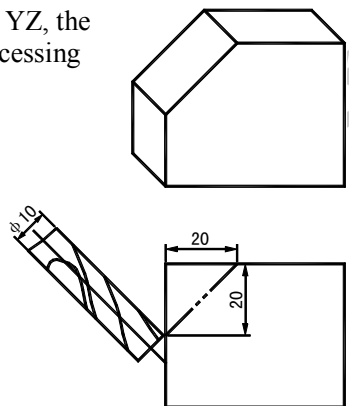

1. Select Plane XZ or YZ.

2. Enter the diameter of the tool (DIA).
3. Enter the start point (ST POS).
4. Enter the end point (ED POS).
5. You may quit the angular surface processing function at will, just key .

Refer to the example:

1)Align for the bank angle, finish tool setting, and key .

LINE-XY

2) Select the processing plane



Key 

Select Plane XZ

LINE-XZ

Key 



3) Enter the diameter of the tool





Key  →  → 



Key 

4) Enter the start point

Key  →  → 





 →  →  →  → 

Key 



 

5) Enter the coordinates of the end point.

Key  →  →  → 

 →  → 

Key 





6)Enter processing state



Key  or  and respectively the position of last/next processing point will

be displayed.

You may quit the angular processing function at will, just key .

H.

The Function Calculator Function

(Be the same with: MIIL_MS)

The Calculation function

Some time it is necessary to calculate out some values during the processing, SDS6 Series digital display boxes are provided with simple Calculation function.



The details are as following:

All the resulted value is displayed on X axis.

 Is the Calculation function key, key it to enter the Calculation function, during using the Calculation function you may quit the function at will, just key the same key.



 the key for Calculating the square root.

 the key for “inverting” trigonometric functions, key it and then key a trigonometric function key for Calculating the inverse trigonometric function.



 trigonometric function key.











 key for canceling last input and the result of last calculation.

 →  , data axis transferring, key them in succession to transfer the resulted value on.

 → , quit data axis transferring.

Example: Key  to enter calculation function.

Perform the following calculation: $10+10 \div 2 \times 5 = 35$

 →  →  →  →  →  →  →  →  →  35

Calculate: $\sin 45^\circ = 0.707$

 →  →  → 0.707

Calculate: $\text{arc sin } 0.707 = 44.991$

 →  →  →  →  →  →  → 44.991

Make the following calculation:

The distance AB in the figure = $\sqrt{10^2 + 30^2} = 31.623$

1 → 0 → × → 1 → 0 → + → 3 → 0
 → × → 3 → 0 → = → √ → 31.623

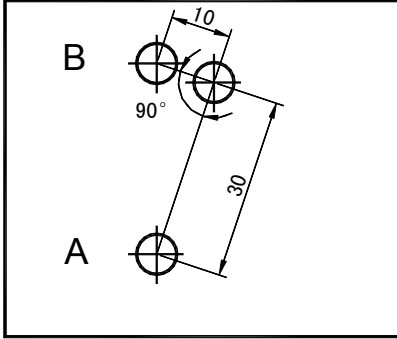

Display for the result:

Transfer the value 31.623 to Y axis.

Key

Key

As shown in the figure, the distance AB=31.623, the tool is at Point A, move the machine table to bring the displayed value into zero, the position of Point B is reached, the processing of Hole B may start.

Quit the resulted value axis transferring function, enter the calculation function again.

Key →

Key to quit the calculation function.

Notes: When the value of input or calculation runs over, the information window display “CTR E”, means the result of calculation is wrong, press key can resume.

I .

Tool Diameter Compensation

(Be the same with: 3V-MIIL_MS)

The Tool Diameter Compensation Function

In the processing of the four sides of the fitting shown in (1), the operator has to run for an additional feeding distance equal the diameter of the tool in every side to complete the processing of the whole length, if the tool diameter compensation function is not used. The tool diameter compensation function provided in the digital display box can make the related compensation automatically.

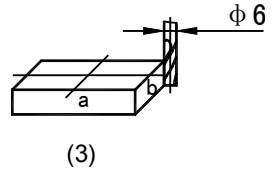
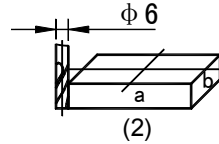
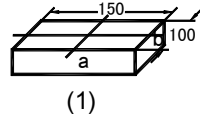

Note: The tool diameter can be made only in the direction of X- or Y- direction.

Operation Procedure:

1. Key  to enter the tool compensation function.
2. Select a processing way among the preset 8 ways (prompt: WHICH).

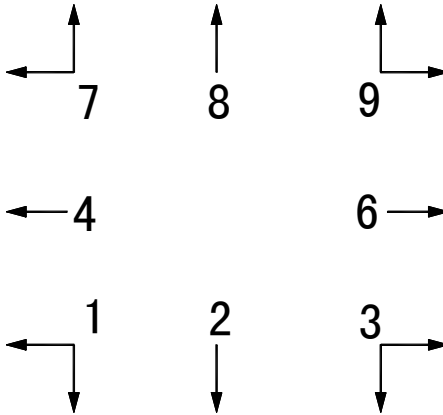

3. Enter the diameter of the tool. (DIA)
4. Enter processing state.

Refer to the operation procedure in a particular example:

The processing of Plane a and of the fitting shown in Fig. (1).

- 1) Key  to enter the tool compensation function.



- 2) Select a processing mode preset.
Start the processing at the position shown in Fig. (2)

Key **9** → **ENT**



- Start the processing at the position shown in Fig. (3)

Key **1** → **ENT**

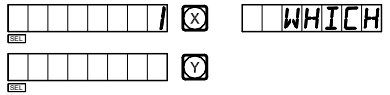

- 3) Enter the diameter of the tool

Key **6** → **ENT**

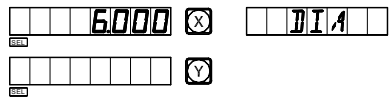

Key **↓**

- 4) Enter processing state

- ① Start the processing at the position shown in Fig. (2)

Move the machine tool to bring the X-axis displayed value into 150.000,

and then move to bring the Y-axis displayed value into 100.000, so, the processing of two peripheral sides finishes.



- ② Start the processing at the position shown in Fig. (3)

Move the machine tool to bring the X-axis displayed value into -150.000

and then move to bring the Y-axis displayed value into -100.000, so, the processing of two peripheral sides finishes.



- 5) You may key **ESC** to quit the tool compensation at will.

J.

200 Tool Storeroom

(Be the same with: LATHE)

200 tool storeroom:

It will need to use different tools when turning different work pieces or different surface of work pieces, so it is necessary to uninstall and adjust the tools, SDS6 digital readout has the function of 200 tools storeroom, which makes the operation simple.

Notice: The function of 200 tools storeroom can't be used but the lathe has the frame of adjusting tool. Please don't use this function if you haven't the frame of adjusting tool.

1. Set a base tool. In the state of "ALE", to clear the display value of the X axis or the Y axis when moving the base tool to touch the frame of adjusting tool.

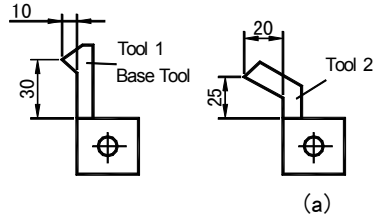

2. Ensure the other tool position relative to the base tool position, which is also the zero point of "ALE" coordinate system, as the figure (a) shows, the relative position of the second tool is:
 X-axis $25-30=-5$, Y-axis $20-10=10$.

3. Number the tool, and store the relative position to the base tool into the digital readout.

4. In process, the operator can input the numbers of using tool, the digital readout will display the relative position dimension of using tool to the zero point of "ALE" coordinate system, moving the lathe platform to make the display of X axis and Y axis become zero.

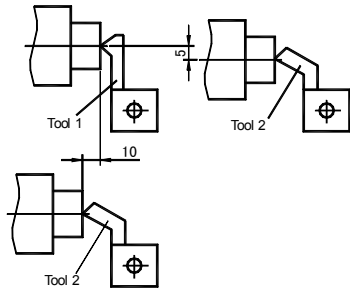

5. The tool storeroom can store datum of 200 tools.

6. If the function of 200 tools storeroom is opened, you can lock this function after you continue to touch the key \oplus 10 times.

If the function of 200 tools is locked, you can unlock this function after you continue touch the key \oplus 10 times. In the state of "ALE".

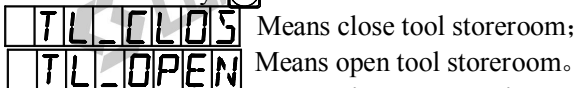

Notes: the Y-axis value mentioned above is the integrated value of Y-axis

with Z-axis, namely the Z/Z0-axis in the former lathe machine readout.

The operation of inputting the datum of tools and calling tool:

1) Please input the datum of tools, in the “ALE” coordinate system, clear the display value when moving the base tool to touch the frame of adjusting tool, set the first tool to the base tool.

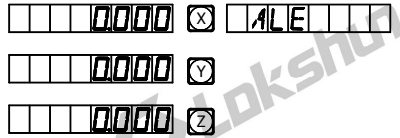

2) Enter the inputting state.

Key



3) Input the datum of next tool.

Key → →



→ →



Key

4) Input the numbers of tool

Key →



Key

5) Input the datum of tool.

Key → → →



→ → →



6) Key continue to input the datum of next tool.

Key quit the inputting state.

You can operate the tool storeroom as below after you input the datum of tools, first install the second tool.

1) Enter the using state.

Key



2) Ensure the base tool.



Key



Default the first tool as the base tool, you can also set the other tool as the base tool, key number is OK. Key

can call other tools.

3) Call the second tool.

Key  → 

4) Exit

Key 



Move the flat-form to make the display value of X axis and Z/Z₀ axis become zero.

The second tool has reached the datum mark, in like manner, the operator can input and call 200 tools.

Notice: You can clear the display value to zero in “ALE” coordinate system only when using the base tool, you can clear the display value to zero in “INC” coordinate system when using other tools.

K.

The Function Of Measure For Taper

(Be the same with: LATHE)

The Function of measure for taper:

The taper of work piece can be measured when turning the taper work piece.

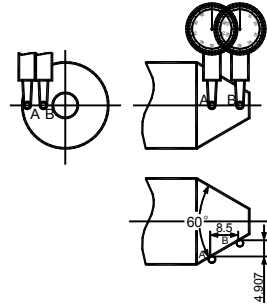

Operation:

As figure shows, the nod of lever meter is touched the position A of work piece surface. Pressing it to make the lever meter point to zero.

- 1) Then entering the function of measure for taper.

Key



- 2) Move the lever meter to position B of work piece surface, press it to make the lever meter point to zero.



- 3) Compute.

Key



The display value of X axis is taper.
The display value of Y axis is angle.

- 4) Quit

Key

L.

(EDM) Matching Output Function

(Be the same with: 3V-EDM)

New type matching output function:

1. Function

This function is used especially for processing by use of discharging processing machine. When the set target valve on Z axis of spark machine is equal to the current value, the digital display case exports switching signals to control the spark machine tool to stop the in depth processing.

Model SDS6-3V digital display case has its direction setup in the Z axis as shown in Fig. 1. Namely, the deeper the depth goes, the bigger the coordinate value displayed on Z axis. The depth goes further ever since the processing is started, and the displayed value on Z axis increases gradually.

According the set direction on Z axis, the processing directions are divided into positive and negative. When the electrode

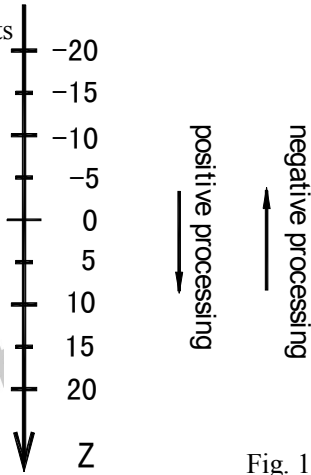

Fig. 1

goes down and processing goes from upper to lower, the value displayed on digital display meter increases, and the processing direction now is “positive”. This direction is then set as normal setup.

When the electrode goes up and processing goes from lower to upper, the displayed value on the digital display meter is reduced, and the processing direction now is “negative”, namely, the “negative processing” as shown is Fig. 1.

Model SDS6-3V digital display case also possesses the “negative anti fire height” function that other cases of similar kinds cannot offer. This function is delivered by a kind of intellectual location tracing, testing and protecting device. In the positive processing, the electrode surface will be covered by a kind of intellectual location tracing, testing and

protecting device. In the positive processing, the electrode surface will be covered by accumulative carbon; in case of long time processing and overtime processing not under control by anybody, such accumulated carbon is not cleaned by anyone; then the electrode

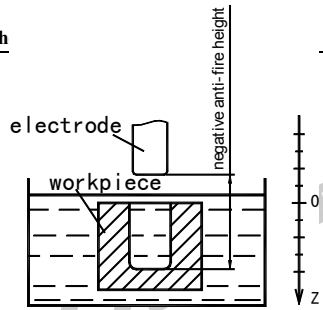

Fig. 2

will increase along the negative direction; and once the electrode exceeds the liquid surface, it may cause a fire accident and incur losses. This function is designed to exactly resolve this problem in setup. Once you set “negative anti fire height”, when the increased height of electrode exceeds its height above the depth of processed surface (i. e. the negative anti fire height), the digital display case will flash alarm signal; meanwhile, its exported signal will automatically shut down the discharging processing machine to avoid any possibility of fire accident (as shown in Fig. 2).

2. Concrete operating methods:

See the concrete processing examples 1, 2 and 3.

- 1) Before processing, first set the parameters “negative anti-fir height”, “exit mode”, and “processing direction”.
- 2) First, move the main axis electrode on Z axis to make it touch work piece datum. Reset \boxed{Z} → \boxed{CLS} or enter a figure.
- 3) Press \boxed{EDM} button, enter your desired depth value(to be displayed on X axis to). Such as 10. Then press $\boxed{\text{F}}$ button to confirm the input value. Afterwards, press the button \boxed{ENT} to exit from “Depth” status. At the same time, enter the “EDM” status to conduct processing.
- 4) X-axis will display “target value of personal location”
Y-axis will display “value of depth reached”. Note: Values on Y-axis means the

depths reached on the work piece by processing.

Z-axis will display “real time value of personal location”. Note: Values on Z-axis mean the values of locations of main axis electrode on Z-axis.

- 5) Start processing. The displayed value on Z-axis gradually gets close to the target value. The displayed value on Y-axis also gets close to the target value. If the electrode is repeated raised and lowered at this time, the displayed value on Z-axis will change accordingly. But the displayed value on Y-axis will not change, and always refer to the value of depth reached by processing.
- 6) When the displayed value on Z-axis is equal to the set target value, the matching switch is shut off, EDM discharging machine will stop processing, and message screen will display “EDM. E”. According to the setup of operators, there are 2 kinds of exit modes:①automatic mode: means automatically exit from the processing status of spark machine, and return to the display status before such processing;②pause mode: “EDM. E” is always displayed, you have to press the  button once to exit and return to the original display status.

3. Set “ERRHIGH”, exit mode and processing direction:

Before processing, you can first set “ERRHIGH”, “exit mode” and “processing direction”.

- 1) Enter “EDM”

Key 

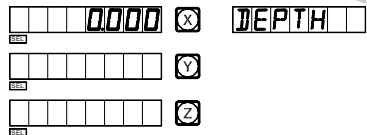



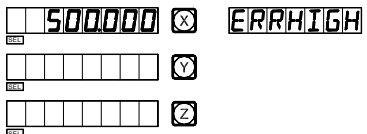

- 2) Enter Setup Mode

Key 



- 3) Set “negative anti-fire height:
Enter a height, i. e. “150”.

Key  →  →  → 

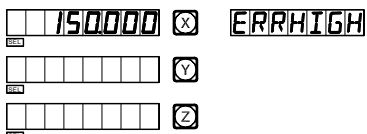

Key

4) Enter the “Exit Mode” Setup.

Key → Set at “pause mode”.

Key

“AUTO” means automatic mode, “STOP” refers to pause mode. If the original exit mode is pause mode, and “STOP” mark appears, press O to display “Automatic mode” to replace the “AUTO ” mark. You can use or to change.

5) Select positive or negative processing direction.

Key → , set at “negative processing”

Positive, Key

Negative, Key

6) choose the EDM process mode

there’s two alterative choice 0 and 1 of EDM MODE:

Press → to choose mode 0.

the relay act as list below:

A power off, relay OFF

B CPU resetting, relay OFF

C CPU start-up, relay ON

D Running function EDM , relay ON

E Reach the depth of function EDM setting, relay OFF

Press → to choose mode 1.



the relay act as list below:

A power off, relay OFF

- B CPU resetting, relay OFF
- C CPU start-up, relay OFF
- D Running function EDM , relay OFF
- E Reach the depth of function EDM setting, relay ON

You shall first make sure the mode is positive processing: in negative processing, for the work piece as shown in Fig. (f), be sure to set at negative processing mode and lead to exit from processing.



6) Exit from setup mode
Key 

You can also set various parameters during processing. When electronic spark processing started, if you find it is necessary to change the originally set “DEPTH”, “ERRHIGH” or “EXIT MODE” and “PROCESSING DIRECTION”, the operator can press  button to enter the setup mode. When the message screen displays “DEPTH”, you can re-ser the depth value; continue to press  button, the screen will display “ERRHIGH”, “AUTO” (or “STOP”) and “POSITIVE” (or “NEGATIVE”) in succession, then you can re-set any item as you choose. Press down the  button until “EDM” is shown, you can return to the processing mode again.

4. Example of Positive Processing:

Example 1: Model Chamber as shown in the processing Fig. (a)

Please make sure the processing direction is positive.

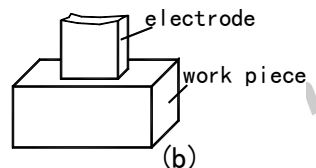
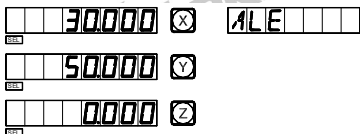
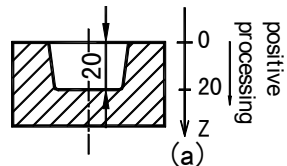

- 1) First move the main axis electrode to make it touch the work piece, as shown in Fig. (b), then press  →  CLS to clear the display.



2) Put in depth of processing.

Key 

3) Enter the depth value.

Key  →  → 

Key 

4) Start processing.

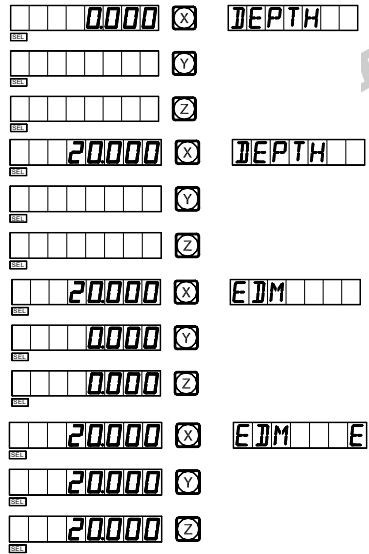

5) “EDM E” display lasts for 3 seconds long.
Return to the state before processing.

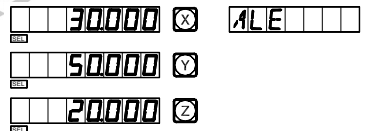

Example 2: Work piece shown in the processing drawing (c).



Please make sure the processing direction is positive.

1) First move the main axis electrode to make it touch the work piece datum, as shown in Fig. (d), then press  →  reset.



  

 

Move the electrode to the shown place in drawing (e).

 





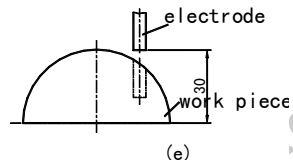
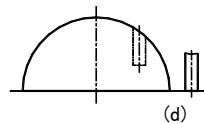
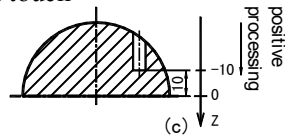

2) Enter "EDM"

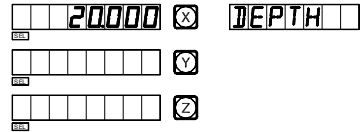
Key 



3) Enter the depth value.

Key  →  →  → 

Key 

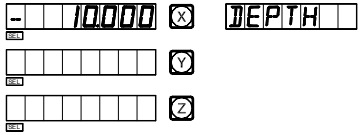

4) Start processing

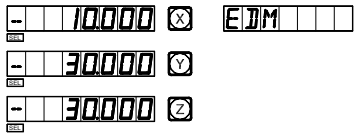

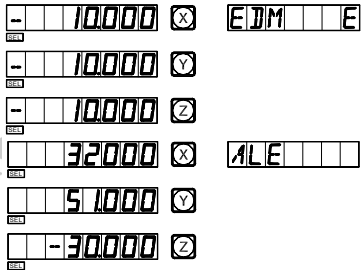

5) Reach the target value. "EDM E" display lasts for 3 seconds and then exits automatically.



5. Example of Negative Processing.

Example 3: Work piece as shown in the processing drawing (f).

Before processing, please make sure the processing is negative.

1) First, move the main axis electrode to make it touch datum place for processing specifications of the work piece as shown in Fig. (g). Then press  →  to clear the display.

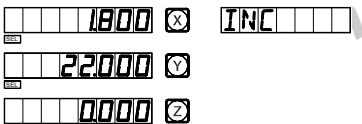

2) |

Key 

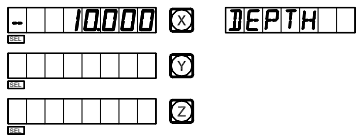
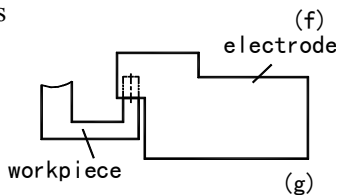
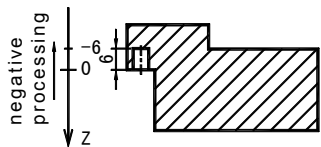

3) Enter the depth value.

Key \pm → 6 → ENT

Key \downarrow

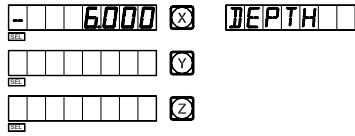

4) Start processing

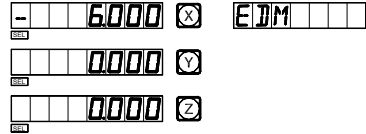

5) Reach the target value. “EDM E” display lasts for 3 seconds and then exits automatically.

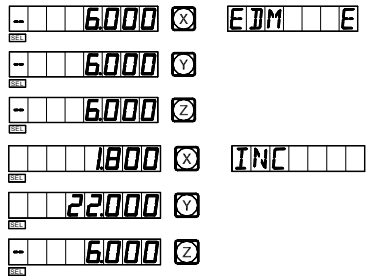

6. A Combined Use of PCD function and EDM function.

PCD and EDM functions can be used in a combination. The operator can first use the PCD function, under the working condition, press \otimes button to exit from PCD; then you can press EDM to enter EDM function to process the work piece; after exiting from EDM, press \otimes button to return to the status when you exited from PCD just now, then you can continue to use PCD function. In such a cycle, you can use the discharging processing machine to process evenly the hole around the circumference.

7. Switch Display Mode Function

In EDM spark processing, if the operator wants to know the XY plane coordinates in the exterior, he can press \odot button, then the message screen displays “EDM. P”; and X axis and Y axis will display the exterior XY planes. Press the \odot button again to return the original EDM display mode. This function only switches between display modes, and does not affect the spark processing.

8. back panel EQUAL OUT port

EQUAL OUT port is connected to the output of relay,
1.0A30DC 0.5A125VAC 0.3A60VDC

| PIN | SIGNAL | COLOR OF WIRE |
|-----|--------|---------------|
|-----|--------|---------------|

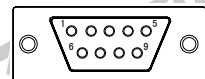

L. (EDM) Matching Output Function(Be the same with: 3V-EDM)

| | | |
|---|------------------|--------------|
| 1 | NC(Normal Close) | Brown |
| 3 | COM(Common) | Blue |
| 5 | NO(Normal Open) | Yellow-green |

M.

Digital Filter Function

(Be the same with: 2V-GRIND)

Digital filter function:

In grinding process, the readout display value will change quickly because of the vibration of the grinding machine, it will made operator indisposed. SDS6-2V special readout for grinding machine has the digital filter function, it delays the readout display value when the grinding machine is vibrating.

The operator can use the digital filter function as follow:

1) Enter the digital filter function.

Key 



2) Key  quit the digital filter function.



Note: The digital filter function can only be used in “INC” or “ALE” mode.

N.

N3 Function

(Be the same with: 2V-MIIL_MS)

the function is suit for Z axis vertical slope machining.

There are four machining mode, as following example:

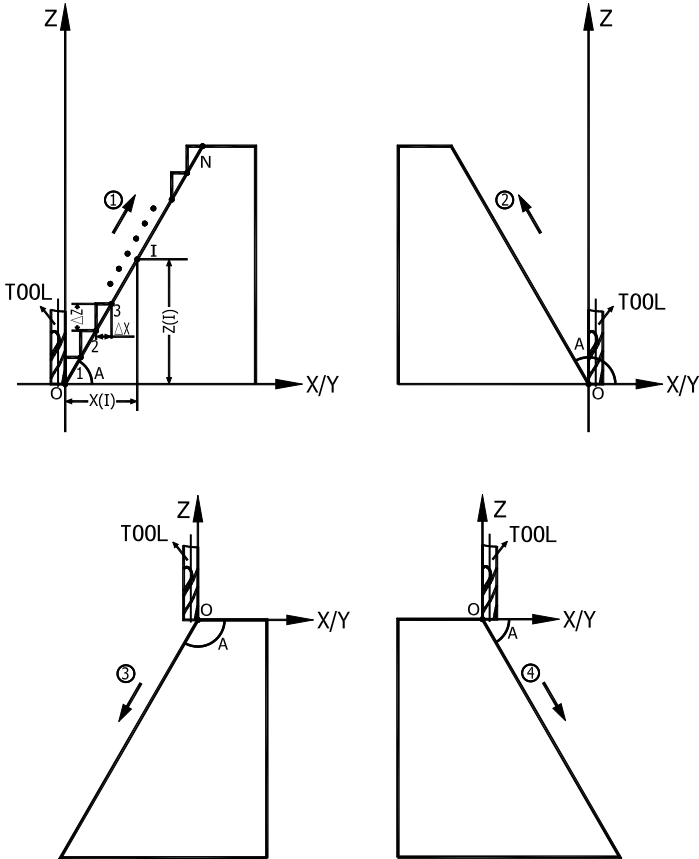

① $\Delta Z=0.1$

$A=60^\circ$

② $\Delta Z=0.1$

$A=120^\circ$

③ $\Delta Z=-0.1$

$A=-120^\circ$

④ $\Delta Z=-0.1$

$A=-60^\circ$

Operation steps was show as fallow: (Take the processing plane XZ as an example)

1) Move the tool to the start point,

Key **X** → **CLS**

X

Y → **CLS** (plane YZ).

Y

2) Key **XZ**, enter N3 function.

3) Key **↓**, select the processing plane.

↓

4) Select plane XZ,

Key **ENT** to ensure

5) Enter the angle.

Key **6** → **0** → **ENT**

X

Key **↓**, next setp

Y

6) Enter the feeding of Z(delta Z)

Key **0** → **.** → **1** → **ENT**

X

Key **↓**, start processing.

Y

(Note: When processing, delta Z of each step is equal.)

7) Point 1, move axis X to 0,
move axis Z 0.1mm forward.

X

Key **↓**, next point.

Y

8) Point 2, move axis X to 0,
 move axis Z 0.1mm forward.
 Key Ⓢ , next point.

| | | | | | | | | | | | | |
|--|--|--|--|------|---|---|---|--|--|--|--|---|
| | | | | 0055 | ⓧ | X | Z | | | | | 2 |
| | | | | 0200 | | Ⓢ | | | | | | |

9) Point 3, move axis X to 0,
 move axis Z 0.1mm forward.
 Key Ⓢ , next point.

| | | | | | | | | | | | | |
|--|--|--|--|------|---|---|---|--|--|--|--|---|
| | | | | 0060 | ⓧ | X | Z | | | | | 3 |
| | | | | 0300 | | Ⓢ | | | | | | |

⋮

⋮

The last point

10) The last point, move axis X to 0,
 move axis Z 0.1mm forward.

| | | | | | | | | | | | | |
|--|--|--|--|-------|---|---|---|-----|--|--|--|--|
| | | | | 0060 | ⓧ | X | Z | 120 | | | | |
| | | | | 12000 | | Ⓢ | | | | | | |

11) Key Ⓢ , quit N3 function,
 digital readout show the current
 XY value.

| | | | | | | | | | | | | |
|--|--|--|--|-------|---|-----|--|--|--|--|--|---|
| | | | | 12875 | ⓧ | ZER | | | | | | 1 |
| | | | | 10000 | | Ⓢ | | | | | | |

12) Validate the value using the equation below:

$$X_{(I)} = \frac{\Delta Z}{\text{tg}A} \times I \quad \Delta X = \frac{\Delta Z}{\text{tg}A}$$

$$Z_{(I)} = \Delta Z \times I$$

I Step number.

Delta X: feed of axis X between each step.

Delta Z: feed of axis Z between each step.

XI: displacement of axis X in the Ith point.

ZI: displacement of axis Z in the Ith point.

(Note: the processing on plane YZ is the same with plane XZ.)

O.

The Progressive Progressing of rectangular Inner chamber

(Be the same with: 2V-MIIL_MS)

The progressive progressing of rectangular inner chamber

When the job is to process the inner chamber of the fitting shown by the working drawing of Fig. (1), the progressive inner chamber processing function may be used; and referring to the prompts the operator can operate easily. As shown in Fig. (3), the processing starts from the center of the inner chamber and goes on along the arrow direction.

Operation procedure:

1. Key to enter the progressive inner chamber processing function.
2. Enter the diameter of the tool (DIA).
3. Enter the position of the inner chamber (CT POS) (the position with respect to center of the tool).
4. Enter the size of the inner chamber.
5. Enter processing state.

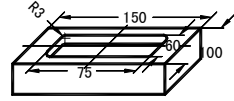

(1)

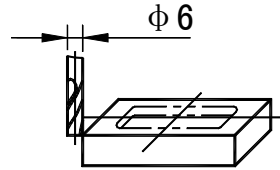

(2)

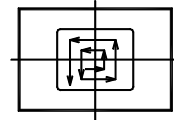

(3)

The operation procedure in an example:

The processing of the inner chamber of the fitting shown in Fig. (1).

- 1) Finish tool setting as shown in Fig. (2), reset, and key to enter the function.



- 2) Enter the diameter of the tool

Key →

Key



- 3) Enter the position of the center of the inner chamber.

Key → → →

→ → →

Key



- 4) Enter the size of the inner chamber

Key → → →

→ → →

Key





- 5) Enter processing state.



- 6) Move the machine table to bring the displayed values on both X- and Y-axes into zero.



- 7) Key  to display the processing position of next step, refer to the prompts and move the machine to bring the displayed values on both X- and Y- axes into zero.

You may quit the progressive inner chamber processing function at will, just key .

Additional sheet:

I. What the user must know:

1. The digital display box must be handle carefully.
2. The box must be grounded properly.
3. Power voltage selection: AC 80V~260V
50 Hz~60 Hz
4. Power consumption: 25VA
5. Working temperature: 0°C~45°C
6. Storage temperature: -30°C~70°C
7. Relative humidity: <90%(20±5°C)
8. Weight: ≈3.2 kg
9. There must not obviously be corrosive gases around the box.
10. Number of coordinates: 2 coordinates, 3 coordinates.
11. Display: 7 digit with plus and minus symbol display (2 axes or 3 axes),
the message window displays by means of 8 star character display device.
12. Frequency multiplication: 4X
13. Allowable input signal: TTL square wave.
14. Allowable input signal frequency: ≤5M Hz
15. Length resolution: 5μm, 1μm,10μm, 0.1μm, 0.2μm, 0.5μm.
16. Operation keyboard: Sealed diaphragm touch keys.
17. The input interface definition of Length Measuring Linear Raster Ruler:(9_pin socket)

| | | | | | | | | | |
|--------|------|----|------|------|------|---|-----|---|---|
| Pin | 1 | 2 | 3 | 4 | 5 | 6 | 7 | 8 | 9 |
| Signal | Null | 0V | Null | Null | Null | A | +5V | B | Z |

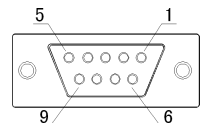

II. Trouble shooting and handling:

Troubleshooting of Grating Ruler and Digital display Meter

The following troubleshooting is primary only. If there are still problems, do not dismantle them by yourself, seek help from our company or corresponding agents.

| Symptom of failure | Source of failure | Troubleshooting |
|---|---|---|
| Digital display meter does not display | <ol style="list-style-type: none"> 1. Is it connected to power supply? 2. Is power switch closed? 3. Is appropriate mains voltage used? 4. Shorting of power supply inside grating ruler. | <ol style="list-style-type: none"> 1. Check power wire, then switch on power supply. 2. Close the power switch. 3. Mains voltage should be within 60~260V. 4. Disconnect plug of grating ruler. |
| Enclosure of digital display meter is charged. | <ol style="list-style-type: none"> 1. Is enclosure of machine tool and digital display meter well grounded? 2. Is there electric leakage from 220V power supply to the ground? | <ol style="list-style-type: none"> 1. Well ground enclosure of machine tool and digital display meter 2. Check 220V power supply. |
| One axis of digital display meter does not count. | <ol style="list-style-type: none"> 1. Exchange with the grating ruler on the other axis, and then operate to see if it no longer counts. 2. Is digital display meter in some special function? | <ol style="list-style-type: none"> 1. If counting is normal failure of grating ruler. If counting is abnormal failure of digital display meter. 2. Exit special function. |

| Symptom of failure | Source of failure | Troubleshooting |
|---|---|--|
| Grating ruler does not count | <ol style="list-style-type: none"> 1. Grating ruler falls outside the usable range of length, reading head cracked up. 2. Reading head of grating ruler rubs ruler enclosure, and aluminum chips piled up. 3. Too much gap between reading head of grating ruler and ruler body. 4. Metal hose parts of grating ruler (plugs, hoses, connectors) burnt, squeezed, broken to cause shorting or breaking of inner circuits. 5. Time of service of grating ruler too long, some inner parts or components go wrong. | <ol style="list-style-type: none"> 1. Repair the grating ruler. 2. Repair the grating ruler. 3. Repair the grating ruler. 4. Repair the grating ruler. 5. Repair the grating ruler. |
| Grating ruler does not count sometimes. | <ol style="list-style-type: none"> 1. Carriage body of grating ruler apart from friction ball. 2. Some part of small grating piece inside reading head of grating ruler wears out. 3. There is dirt on some part of grating inside enclosure of grating ruler. 4. Insufficient elasticity of carriage steel wire inside reading head of grating ruler. | <ol style="list-style-type: none"> 1. Repair the grating ruler. 2. Repair the grating ruler. 3. Repair the grating ruler. 4. Repair the grating ruler. |

III. Structural principle

Our linear encoder and digital readout are high technologic production that is combined with photo electronic technology, precision mechanical technology, microelectronic technology and computer technology, and so on. The customer without being trained may not repair this system. The structural principle is as follows.

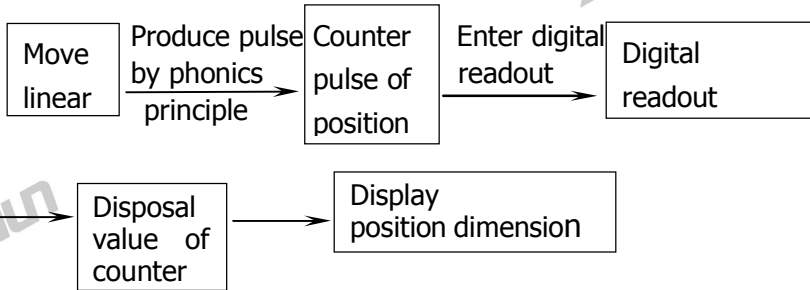

IV. Install figure

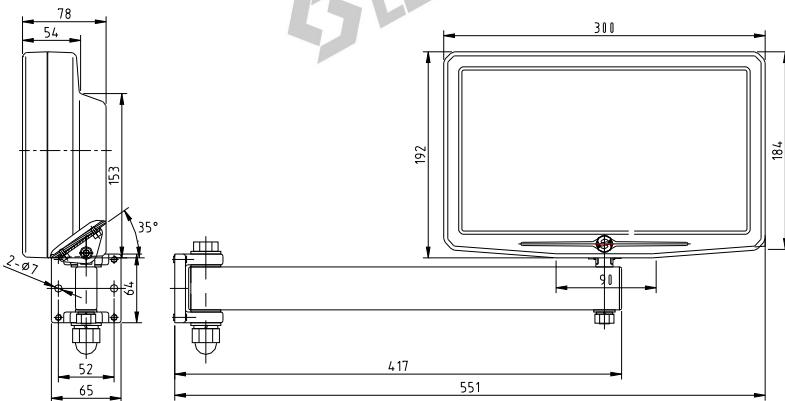

- notice: 1、cliping the power and signal wire to avoid stumbling.
2、install height is 1350mm from the operator standing floor.

V. product packaging bill

- 1、 a piece of SDS6 series digital readout
- 2、 a piece of power wire
- 3、 a copy of operating instruction
- 4、 A copy of verified certificate
- 5、 A piece of dustproof cover
- 6、 a piece of wire clip
- 7、 a piece of bracket

Dear users:

Thank the purchase and use of Guangzhou Lokshun CNC Equipment Ltd' product! In order to make our services make you more satisfied after the purchase, please read the following instructions:

Products shall be delivered with "Three Guarantees" and 15-day limited replacement and free repair within the period of one warranty year (from date of sale). Accessories must be complete in replacement:

The following few services are not free:

- 1、 over one year warranty;
- 2、 abnormal damage due to failure of comply with requirements of using, maintain and storage;
- 3、 damage caused by the unauthorized mender;
- 4、 without a valid invoice (except the products can be proved in warranty year);
- 5、 damage caused by irresistible force.

LOK SHUN CNC EQUIPMENT LTD.

<http://www.sino-ld.com>

Add: No.16wordshop,3rd Industrial Park,Xilang
East Road,Liwan District,Guangzhou

p.c: 510385

Fax: (020) 81617180

Tel: (020) 81617181,81622771

Hotline: (020) 81622533

E-mail: infos@sino-ld.com